



GONG MAW ENTERPRISE CO., LTD



**ONE
PLIER
WHOLE
LIFE**

The Company

One plier, whole life.

GONG MAW, was established in 1979, a professional Locking Pliers manufacturer in Taiwan.

We have over 40 - years experiences of specializing in production and development of locking pliers.

We are a professional OEM & ODM manufacturer. And we dedicated to developing and innovating the products and provide satisfied service to every customer.

GONG MAW sells locking pliers around the world, and also produces for many international famous brands.

Our customers are throughout North America, South America, Europe, Asia, Middle East and etc.

GONG MAW Locking Pliers obtain approvals and patents from many countries, and are widely applicable in various fields.

Discover our items in this brochure, one plier, whole life.



1979

2013



- ISO9001:2008 Certification 2013**
- Seven basic tools of quality
 - PDCA Cycle
 - Statistical Process Control

2018



- ISO9001:2015 Certification 2018**
- Strategic Directions
 - Strategic Action Plan
 - Risk Assessment
 - Management Control Center
 - Knowledge Management System

2020



- GS Certificate**
- Product function verification process
 - Product safety evaluation index
 - Annual product audit

2021



- Sedex Certification (Future Plan)**
- The Rights of Freedom of Association and Collective Bargaining
 - Fair Remuneration
 - Occupational Health and Safety
 - Special Protection for Young Workers
 - No Bonded Labour
 - Ethical Business Behaviour
 - No Discrimination
 - Decent Working Hours
 - No Child Labour
 - No Precarious Employment
 - Protection of the Environment

Comprehensive Inspection Equipment

More effective way and more reliable.

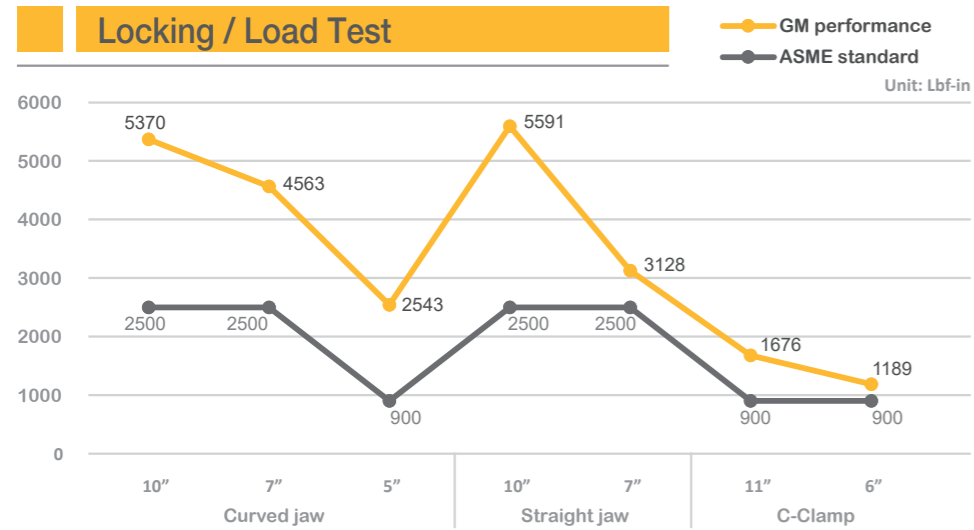

Universal Testing Machine



Load Test



Life Cycle Testing Machine



Pre-set of locking force

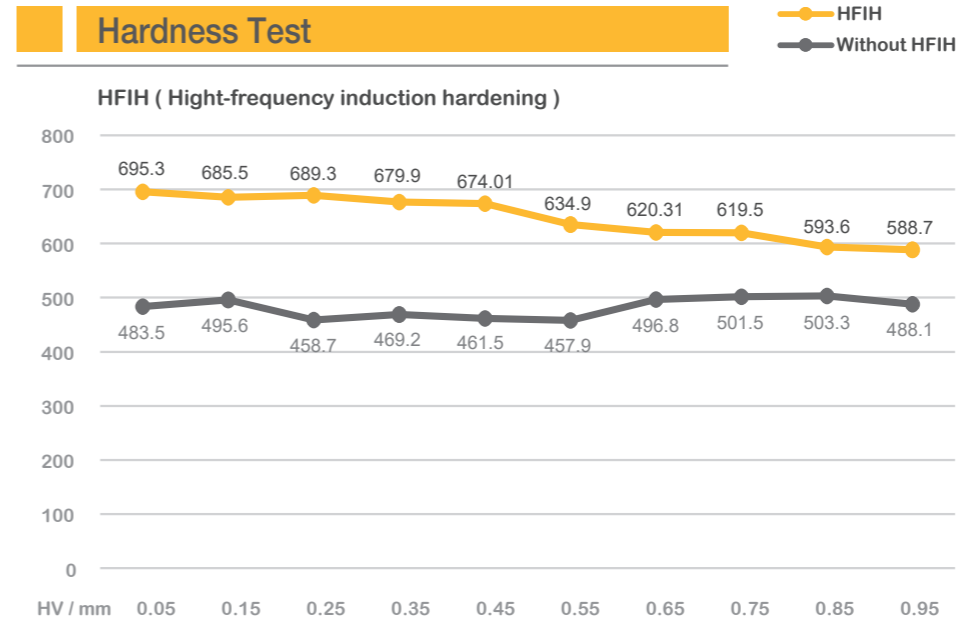

- 9001:2015
- Measurement and monitor
 - Products and processes
 - Customer satisfaction
 - Continual improvement



Cutting Machine



Metallographic Grinding, Polishing, Mounting Machine



Mounting Press and Polishing



Impact Machine

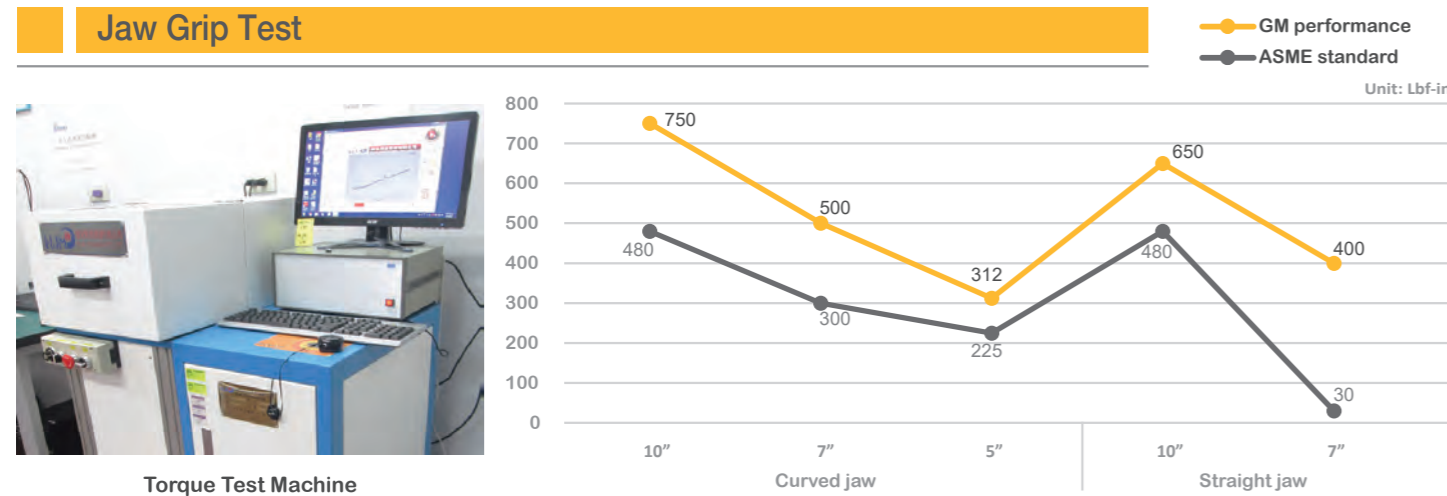

Torque Test Machine



Vickers Hardness Tester

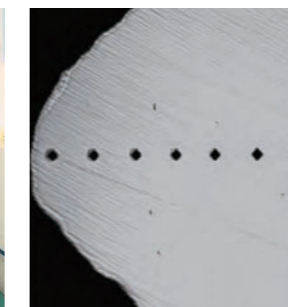

10X-50X zoom magnification range



Vickers Hardness Testing



Impact Testing

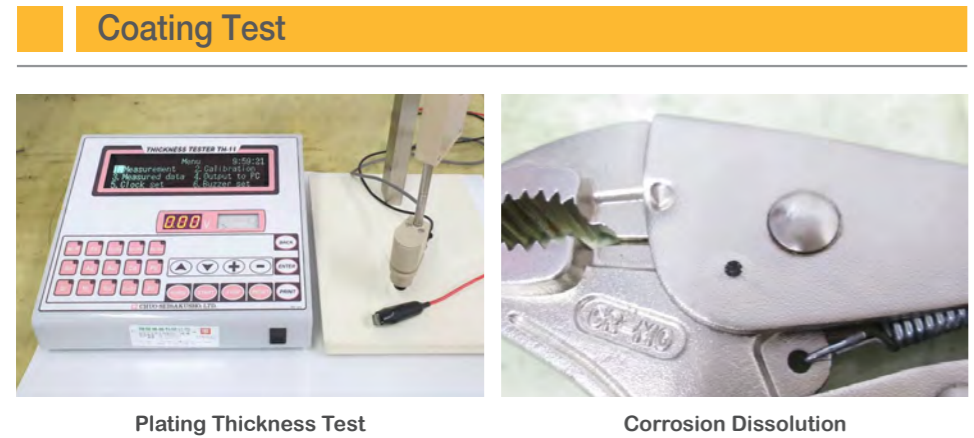

Plating Thickness Test

Corrosion Dissolution



Salt Spray Tester

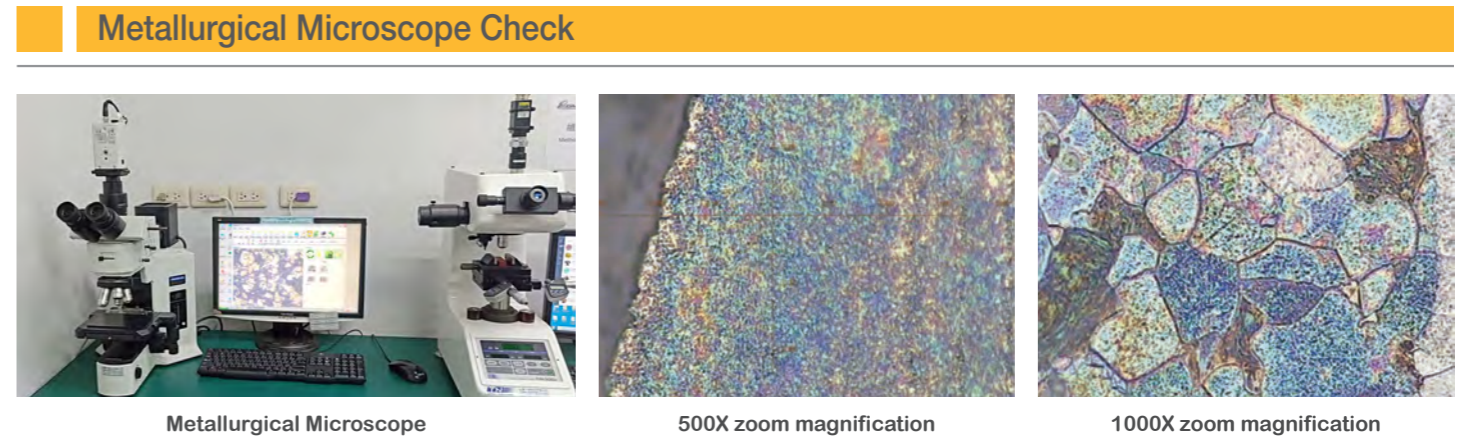

Metallurgical Microscope

500X zoom magnification

1000X zoom magnification

Work Organization

5S is a workplace organization method of Japanese origin.

5S is a system for organizing spaces so work can be performed efficiently, effectively, and safely. This system focuses on putting everything where it belongs and keeping the workplace clean, which makes it easier for people to do their jobs without wasting time or risking injury.

5S

Remove all unnecessary items from the workplace; only keep the items you need.



SEIRI

Put everything into its proper place: a place for everything and everything in its place.



SEITON

Create a clean worksite without garbage, dirt and dust, so problems can be more easily identified.



SEISO

Setting up standards for a neat, clean, workplace.



SEIKETSU

Support and spread this mindset and behaviour across the organization.



SHITSUKE



Range And Items

Each professional processing needs to find an effective solution.

FORGING



PRESSING



BRAZING

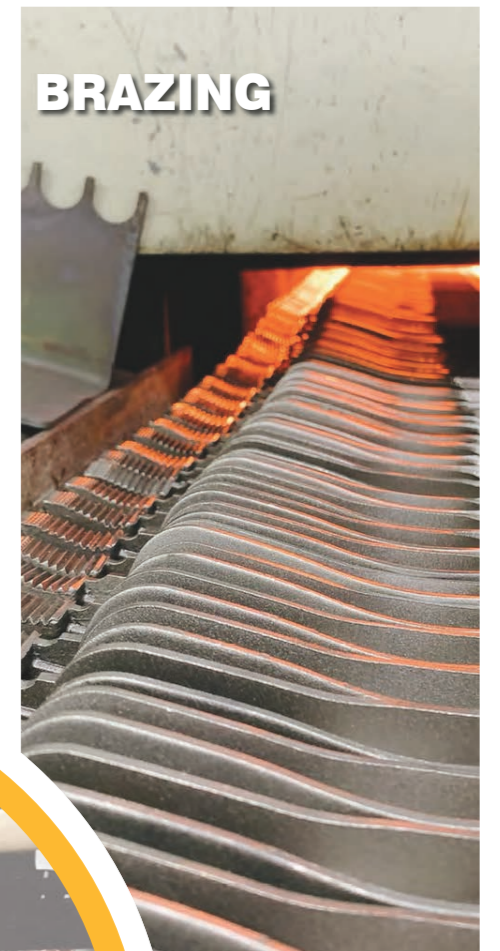

OEM & ODM



INJECTION MOLDING



PAD PRINTING



















MACHINING



Table Of Contents

Product range.

10 - 17	Locking Pliers	
	Curved Jaw Locking Pliers	10
	X-Jaw Locking Pliers	11
	Straight Jaw Locking Pliers	11
	Long Nose Locking Pliers	12
	Round Jaw Locking Pliers	12
	V Jaw Locking Pliers	13
	W Jaw Locking Pliers	13
	Large Jaw Locking Pliers	14
	Lift Support Pliers	15
	Hose Clamp Locking Pliers	15
	Oil Filter Master Pliers	16
	Parallel Jaw Locking Pliers	16
	Mini Clamp Locking Pliers	17
	Self-Evening Jaw Locking Pliers	17
18	Locking Chain Wrenches	
	Locking Chain Wrenches	18
	Cutting Chain Wrenches	18
19 - 20	BSET Series Locking Pliers	
NEW	BSET Series Locking Pliers	20
21 - 24	Automatic Locking Pliers	
	Automatic Curved Jaw Locking Pliers	23
	Automatic Straight Jaw Locking Pliers	23
	Automatic Long Nose Jaw Locking Pliers	24
	Automatic Welder's Grip Wrench	24
NEW	Automatic Locking C-Clamps	24
	Automatic Screw Removal Locking Pliers	26
25 - 26	Screw Removal Locking Pliers	
NEW	Screw Removal Locking Pliers	28
27 - 29	Grip Wrenches	
	Locking Panel Clamps	29
	Welder's Grip Wrenches	30
	Welder's Grip Wrenches Pipe Working	30
	Sheet Metal Grips	31
	Roofers Welder Grip Wrench	31
30 - 32	Pinch Off Pliers	
	Pinch Off Pliers	32
	Hose Clamp Pliers	33
	Pinch Off Locking Pliers	33
	Straight Nose Hose Pinch Pliers	34
	Angle Nose Hose Pinch Pliers	34
33 - 34	Expanding Locking Pliers	
	Expanding Locking Pliers	36
35 - 42	C-Clamps & Table C-Clamps	
	Stepped C-Clamps	38
	Locking C-Clamps With PVC Covered	38
	Locking C-Clamps	39~ 40
NEW	Locking C-Clamps EUR Series	41
	Replaceable Table C-Clamps	43
NEW	Table C-Clamps	44
	T Slot Clamp With Pipe	44
	Drill Press Clamp	44
43 - 44	Woodwork Clamp	
NEW	90° Corner Woodwork Clamp	45
	2-Way Right Angle Woodwork Clamp	46
45 - 46	Axial Welding	
	Axial Welding Pliers Set	47
	Self-locking multi-grip plier Wide flat jaws	48
	Self-locking multi-grip plier Flat jaws set at 90° angle	48
	Self-locking multi-grip plier Double curved jaws	48
	Self-locking multi-grip plier Angled jaws	48
	Self-locking multi-grip plier Wide curved jaws	48
	Self-locking multi-grip plier Straight jaws	48
47 - 48	French Type	
	French Type Adjustable Jaw Locking Pliers	50
49 - 51	German Type	
	Curved Jaw German Type	52
	Parallel Plus Grip Pliers	52
	V Jaw Locking Pliers	52
	VVE Jaw Locking Pliers	52
	Angled Grip Wrench	53
	Welder's Grip Wrenches	53
	Welder's Grip Wrenches Pipe Working	53

52	Parallel grip	
NEW	Parallel grip	54
53	Pistol Grips	
	Pistol Grips	55
54	Locking Pliers Holder	
NEW	Locking Pliers Holder	56
55 - 57	Packaging Design	
	Blister	57
	Hang Card	58
	Box	59
	Other	59

Contact Us

Answer your questions in a timely manner.



www.gongmaw.com

We are looking forward to your contact!



Symbols



Welding



Automotive



Industry



Woodwork



Maintenance



Building

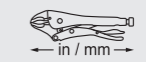

Length



Opening



Weight



Max. Gripper Pipe Diameter



Hex Length

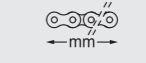

Chain Length



Jaw Width

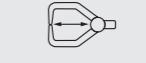

Throat Depth



Screw Head Size

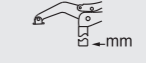

Insertion Diameter



Clamping Thickness



Insertion Depth



Plane Clamping Width



Holding Mechanism



Illustrations, measurements and weights are purely indicative.

Reproduction of the catalog or parts thereof in any form is prohibited without our authorization.

Subject to technical changes and product updates.

Product Features

100% Made in Taiwan.

Please wear protective equipment for your safety.

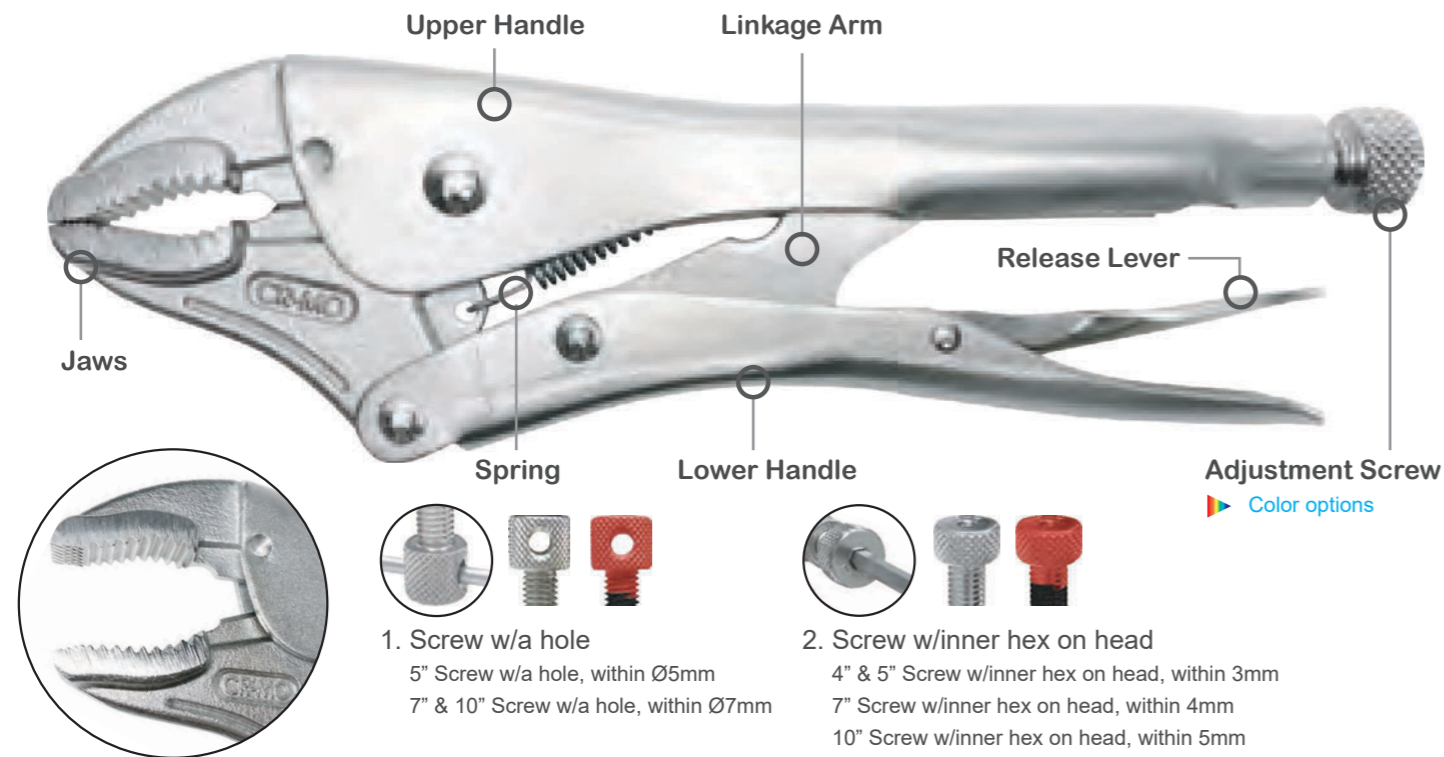

Body Part Introduction

- Handle:** Flowing lines, ergonomic design
- Linkage Arm:** Keeps handles aligned, ensures years of service
- Adjustment Screw:** Adjustable jaw opening with nut smoothly
- Release Lever:** Less releasing effort for easy release type
- Predator jaws:** Firm gripping, high durability, designed to grip from any angle
- Forged steel:** Constructed of heat-treated alloy steel gives you maximum durability and increased gripping power.
- Spring:** Use high carbon steel wire to keep high durability and elasticity after min. 15000 times repeated loading test.

A drop of oil on polished surfaces and joint of pliers will keep the tool in good working order and extend your pliers service life.

Handle Type

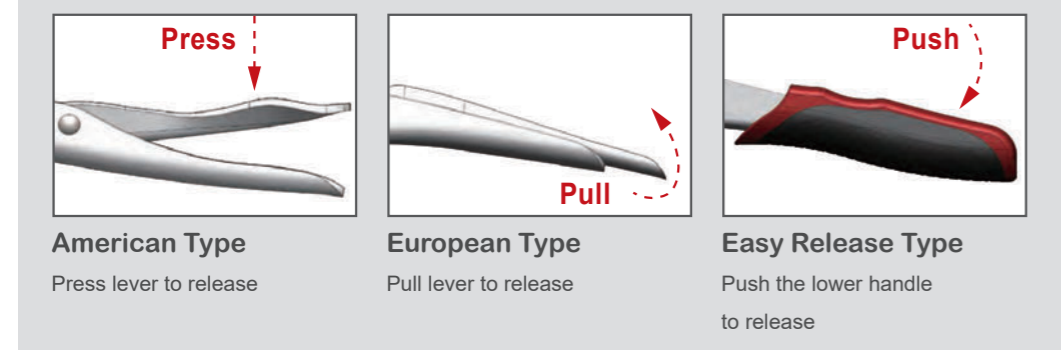

Optional Accessories



Release Lever Grip
Available for American and European Type



Upper Handle Grip
Available for American, European, Easy Release Type



Bottom Handle Grip
Available for Easy Release Type

Curved Jaw Locking Pliers



With Wire Cutter
Suitable for a variety of applications and material shapes. Classic trigger release provides maximum locking force. Including convenient wire cutters for maximum toughness and durability. The hardened teeth are designed to grip for any angle.



Finish: Nickel Plated
Materials: Jaw & Handle Chrome Molybdenum

American Style

Item No.	in / mm	mm	g
304ASI	4" / 100	25	115
305ASI	5" / 125	26	185
307ASI	7" / 175	41	345
310ASI	10" / 250	53	540
312ASI	12" / 300	60	880

European Style

Item No.	in / mm	mm	g
304ASIE	4" / 100	25	115
305ASIE	5" / 125	26	180
307ASIE	7" / 175	41	345
310ASIE	10" / 250	53	540
312ASIE	12" / 300	60	880

Easy Release Style

Item No.	in / mm	mm	g
305ASET	5" / 125	26	210
307ASET	7" / 175	41	390
310ASET	10" / 250	53	560



Curved jaw with serrated teeth can provide strong bite to hex, bolt, nuts, pipes, tubs and etc.

Finish: Nickel Plated
Materials: Jaw & Handle - Chrome Molybdenum

American Style

Item No.	in / mm	mm	g
305CASI	5" / 125	26	185
307CASI	7" / 175	43	345
310CASI	10" / 250	48	540
312CASI	12" / 300	60	880

European Style

Item No.	in / mm	mm	g
305CASIE	5" / 125	26	180
307CASIE	7" / 175	43	345
310CASIE	10" / 250	48	540
312CASIE	12" / 300	60	880

Easy Release Style

Item No.	in / mm	mm	g
305CASET	5" / 125	26	210
307CASET	7" / 175	43	390
310CASET	10" / 250	48	560

Locking Pliers

X-Jaw Locking Pliers



YouTube

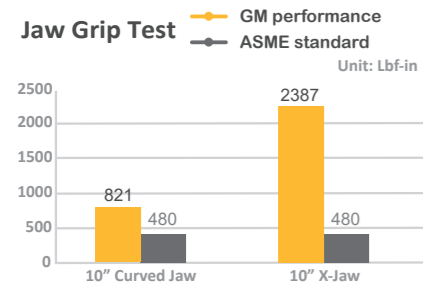

Actual GM test data over ASME standard of 530%(Maximum). X-Jaw provides 3 times more holding force than traditional locking pliers.

The features of X-Jaw locking pliers are clamping force that allows jaw to move not only forward but also upwards. The special teeth and mechanism designs enhance the gripping power up to 3 times more than traditional locking pliers.

Finish: Nickel Plated
Materials: Jaw & Handle - Chrome Molybdenum

American Style



Item No.	in / mm	mm	g
307XA	7" / 175	45	350
310XA	10" / 250	50	530

European Style



Item No.	in / mm	mm	g
307XAE	7" / 175	45	340
310XAE	10" / 250	50	530

Easy Release Style



Color options

Item No.	in / mm	mm	g
307XAET	7" / 175	45	400
310XAET	10" / 250	50	575

Straight Jaw Locking Pliers



Straight Jaw



Straight jaws provides maximum contact on flat, square or hexagonal workpieces. Suitable for tightening, clamping, twisting and turning rotary screws to adjust the pressure and suit the job. Adjust for reuse. Made of advanced heat treated alloy steel for maximum toughness and durability. Hardened teeth are designed to grip from any angle.

Finish: Nickel Plated
Materials: Jaw & Handle - Chrome Molybdenum

American Style



Item No.	in / mm	mm	g
305RASI	5" / 125	23	190
307RASI	7" / 175	33	385
310RASI	10" / 250	43	550

European Style



Item No.	in / mm	mm	g
305RASIE	5" / 125	23	190
307RASIE	7" / 175	33	385
310RASIE	10" / 250	43	550
312RASIE	12" / 300	65	825

Easy Release Style



Color options

Item No.	in / mm	mm	g
305RASET	5" / 125	23	230
307RASET	7" / 175	33	435
310RASET	10" / 250	43	585

Long Nose Locking Pliers



With Wire Cutter

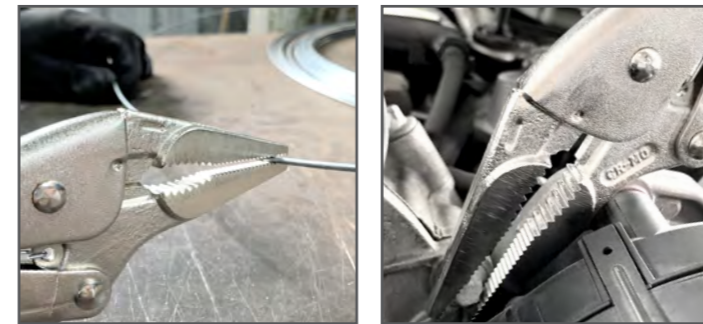

Long nose locking pliers with wire cutter is ideal for precision work with a long, straight nose that provides a secure grip in narrow and hard-to-reach areas.

Finish: Nickel Plated
Materials: Jaw & Handle - Chrome Molybdenum

American Style



Item No.	in / mm	mm	g
304LA	4" / 100	44	110
306ASI	6" / 150	52	200
309ASI	9" / 225	73	375

European Style



Item No.	in / mm	mm	g
304LAE	4" / 100	44	110
306ASIE	6" / 150	52	200
309ASIE	9" / 225	73	375

Easy Release Style



Color options

Item No.	in / mm	mm	g
306ASET	6" / 150	52	215
309ASET	9" / 225	73	425

Round Jaw Locking Pliers



With Wire Cutter



80% Maximum Grip

Round jaw locking pliers are suitable for removing rust or deformed nut. The heavy-duty jaws creates 3 touching points on the nut, hex or bolt which can hold the object securely, and do not slip or damage.

Finish: Nickel Plated
Materials: Jaw & Handle - Chrome Molybdenum

American Style



Item No.	in / mm	mm	g
307N	7" / 175	11-21	330
310N	10" / 250	15-27	610

European Style



Item No.	in / mm	mm	g
307NE	7" / 175	11-21	330
310NE	10" / 250	15-27	610



With Wire Cutter

American Style



Item No.	in / mm	mm	g
304N	4" / 100	7-16	115

European Style



Item No.	in / mm	mm	g
304NE	4" / 100	7-16	115

Locking Pliers

V Jaw Locking Pliers



With Curved Lower Jaw



V jaw with straight tip allows to hold both round and flat material. Variety of applications, such as loosen/tighten bolt, hex, nut as a wrench.

Finish: Nickel Plated
Materials: Jaw & Handle - Chrome Molybdenum

American Style



Item No.	in / mm	mm	g
307EEAI	7" / 175	40	330
310EEAI	10" / 250	43	515
312EEAI	12" / 300	70	910

European Style



Item No.	in / mm	mm	g
307EEAIE	7" / 175	40	330
310EEAIE	10" / 250	43	515
312EEAIE	12" / 300	70	910

Easy Release Style



Color options

Item No.	in / mm	mm	g
307EEAET	7" / 175	40	400
310EEAET	10" / 250	43	585

W Jaw Locking Pliers



With the W-shaped jaw, no matter round, cross-section and flat material can be firmly gripped. And the small-opening in front of the jaw can hold small size screw or tube securely to do any process.

Finish: Nickel Plated
Materials: Jaw & Handle - Chrome Molybdenum

American Style



Item No.	in / mm	mm	mm	g
310CV	10" / 250	66	55	635

European Style



Item No.	in / mm	mm	mm	g
310CVE	10" / 250	66	55	635

Easy Release Style



Color options

Item No.	in / mm	mm	mm	g
310CVAET	10" / 250	66	55	675



Large Jaw Locking Pliers

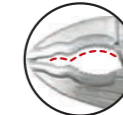

With Two Diameter

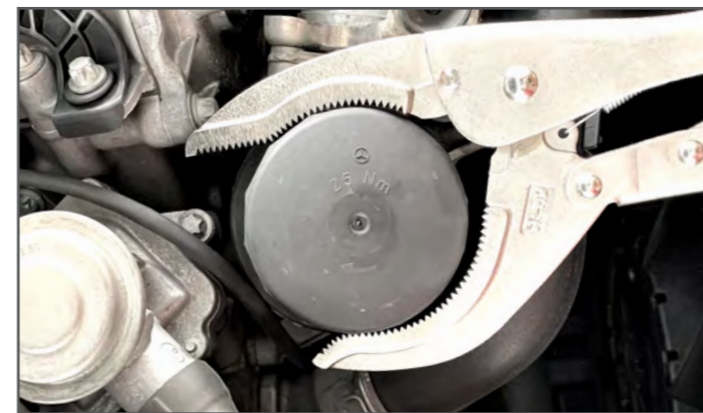

Large curved jaw with serrated teeth allows to grip bigger or larger material, like nut, bolt, hex, round stick, tube, angle stock and etc. ideal for tightening, clamping, twisting and turning. The straight front tip allows to clamp, hold flat materials, such as sheet metals. Constructed of high-grade heat-treated alloy steel for maximum toughness and durability.

Finish: Nickel Plated
Materials: Jaw & Handle - Chrome Molybdenum

American Style



Item No.	in / mm	mm	g
312LJ	12" / 300	96	685

European Style



Item No.	in / mm	mm	g
312LJE	12" / 300	96	685

Easy Release Style



Color options

Item No.	in / mm	mm	g
312LJAET	12" / 300	96	725



Finish: Nickel Plated
Materials: Jaw & Handle - Chrome Molybdenum

American Style



Item No.	in / mm	mm	mm	mm	g
311ASI	10" / 250	51	6.5	15	570

European Style



Item No.	in / mm	mm	mm	mm	g
311ASIE	10" / 250	51	6.5	15	570

Easy Release Style



Color options

Item No.	in / mm	mm	mm	mm	g
311ASET	10" / 250	51	6.5	15	590

Locking Pliers

Lift Support Pliers



Aluminum



4 inch size can be put in a bag without occupying much space or simply put into your pocket and use it when needed.



Aluminum jaw protects the hood struts from scratch. Support the hood and cylinder lift on the luggage. The pliers securely secure the lift bracket and allow access to the engine compartment or trunk area.

Finish: Jaw - Anode Treatment
Handle - Nickel Plated
Materials: Jaw - Aluminum
Handle - Chrome Molybdenum

American Style



Item No.	in / mm	mm	g
304AL	4" / 100	18	90

Hose Clamp Locking Pliers



Mesh Jaws

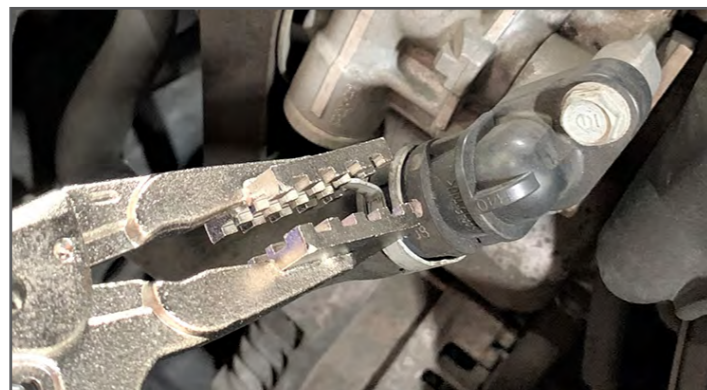

The Innovative mesh jaws securely hold the wire springs in place. Clamp the hose clamp with a locking force to increase productivity. Suitable for automobile repair, maintenance, and etc.

Finish: Nickel Plated
Materials: Jaw & Handle - Chrome Molybdenum

American Style



Item No.	in / mm	mm	g
306HCX	6" / 150	37	245
309HCX	9" / 225	66	430

European Style



Item No.	in / mm	mm	g
306HCXE	6" / 150	37	245
309HCXE	9" / 225	66	430

Easy Release Style



Color options

Item No.	in / mm	mm	g
306HCXAET	6" / 150	37	380
309HCXAET	9" / 225	66	470

Oil Filter Master Pliers



Removing and installing the oil filter from cars, trucks, motorcycles, ATVs and lawn and garden equipment. Oil filter master pliers can be adjusted and fixed at any angle to suit the installation, removal and tightening of any shape.



Finish: Nickel Plated
Materials: Jaw & Handle - Chrome Molybdenum

American Style



Item No.	in / mm	mm	g
306MP	10" / 250	55~110	440
313MP	12" / 300	50~120	630

European Style



Item No.	in / mm	mm	g
306MPE	10" / 250	55~110	440
313MPE	12" / 300	50~120	630

23°

Bent (Angle: 23°) model is ideal for a limit space

American Style



Item No.	in / mm	mm	g
306MPL	10" / 250	55~110	440
313MPL	12" / 300	50~120	630

European Style



Item No.	in / mm	mm	g
306MPLE	10" / 250	55~110	440
313MPLE	12" / 300	50~120	630

Parallel Jaw Locking Pliers



With Swivel Pad



Swivel lower jaw allows to clamp or hold irregular materials or uneven surface. Serrated upper jaw provides a firm grip on materials.

Finish: Nickel Plated
Materials: Jaw & Handle - Chrome Molybdenum

American Style



Item No.	in / mm	mm	g
510SP	10" / 250	35	555

European Style



Item No.	in / mm	mm	g
510SPE	10" / 250	35	555

Easy Release Style



Color options

Item No.	in / mm	mm	g
510SPAET	10" / 250	35	600

Locking Pliers

Mini Clamp Locking Pliers



With Swivel Pads



This unique C-Clamp features a short throat depth that locks on the object and snaps closed instantly. With shortened installation times, it helps you get a strong grip on irregular shaped pieces to keep them steady while you work.

Finish: Nickel Plated
Materials: Jaw & Handle - Chrome Molybdenum

American Style



Item No.	in / mm	mm	g
510CP	10" / 250	30	570

European Style



Item No.	in / mm	mm	g
510CPE	10" / 250	30	570

Easy Release Style



Color options

Item No.	in / mm	mm	g
510CPAET	10" / 250	30	610

Self-Evening Jaw Locking Pliers



With Swivel Pads

Use the swivel pads with wide open jaws for more functionality and clamping, this hand tool get a firm grip on oversize and irregular workpiece, and hold strong on all surface.

Finish: Nickel Plated
Materials: Jaw & Handle - Chrome Molybdenum

American Style



Item No.	in / mm	mm	g
310WP	10" / 280	100	690

European Style



Item No.	in / mm	mm	g
310WPE	10" / 280	100	690

Easy Release Style



Color options

Item No.	in / mm	mm	g
310WPAET	10" / 280	100	730



Locking Chain Wrenches

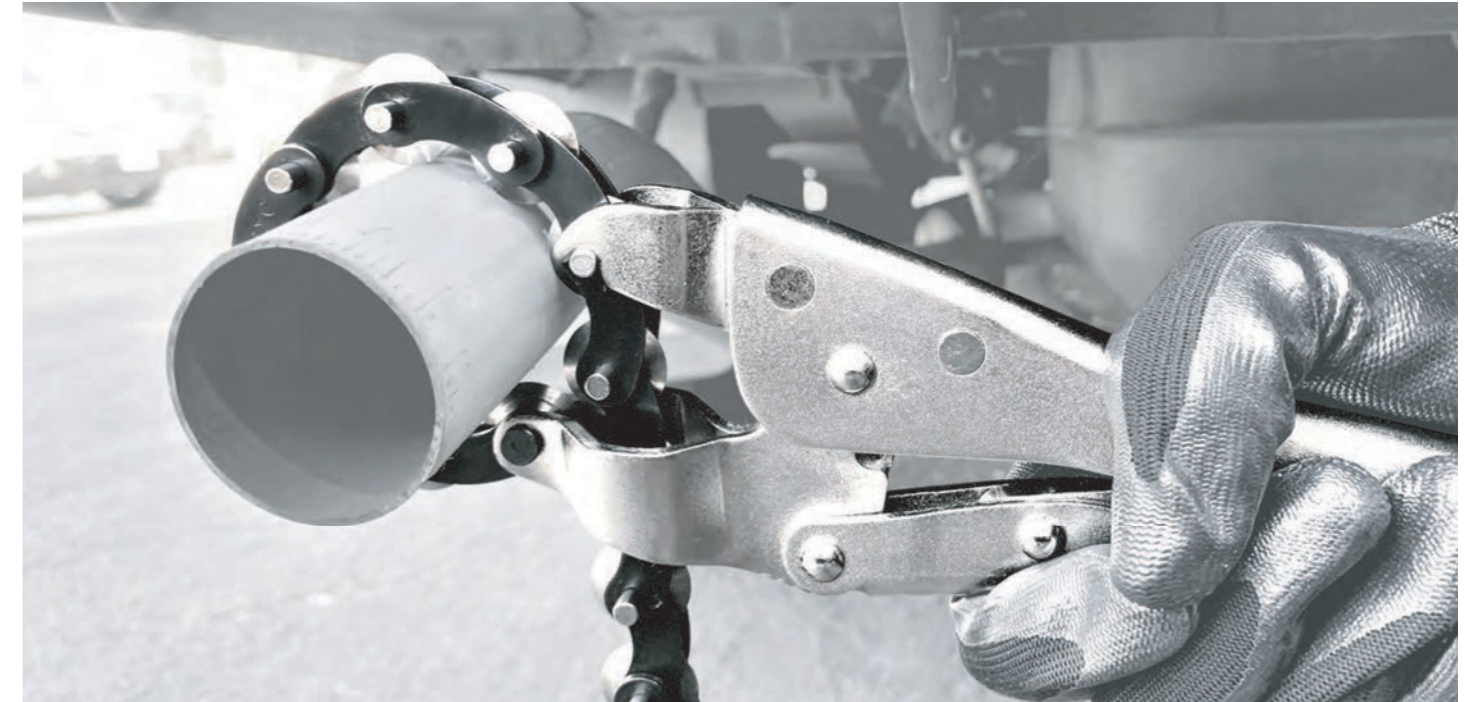

Locking Chain Wrenches



The locking chain wrench can be easily threaded through a tight spot or limited space. Ideal for holding or locking around any shape or size of materials.

Finish: Nickel Plated
Materials: Jaw & Handle - Chrome Molybdenum

American Style



Item No.	in / mm	mm	g
320R	9" / 225	500	755
323R	9" / 225	600	830

European Style



Item No.	in / mm	mm	g
320RE	9" / 225	500	755
323RE	9" / 225	600	830

Cutting Chain Wrenches



By simple rotating, it is easy and quick to cut thin wall pipes. Eliminates hand gripping effort and ensures aligned, straight cutting. Adjusting T-knob for easy tension increasing.

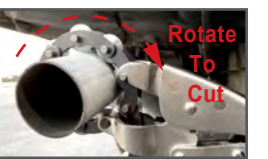

Finish: Nickel Plated
Materials: Jaw & Handle - Chrome Molybdenum

American Style

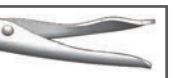

Item No.	in / mm	mm	g
513RC	9" / 225	290	720
523RC	9" / 225	350	760

European Style



Item No.	in / mm	mm	g
513RCE	9" / 225	290	720
523RCE	9" / 225	350	760

BSET Series Locking Pliers

Best Ever! Gender Friendly, Green energy and environmental protection.

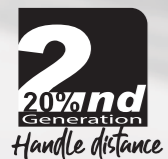

- One-hand Operation
- Ergonomic Handle Design
- 2nd Generation Easy Release Type

BSET series adjusts the joint construction to shorten the holding gap between upper and lower handle. Therefore, it is easier for one-hand usage. During the one-hand operation, the other hand could assist in the gripping for a preferred action.



* Ergonomic handle

Is not only to consider the product shape, but also focus on the steady holding force and comfort. In this case, it will improve the work efficient and prevent the damage due to tired holding during long-time work.

* Improved construction

Reduce 20% hand-holding margin to release the bearing of hand.



* Release Force Saving

Not only save 60% release force during the work, but also relax the tired holding of hands.

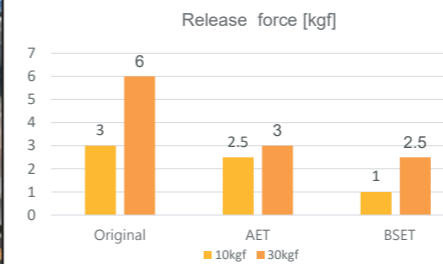

* Clamping Force Upgraded

User could hold the pliers firmly due to the 20% holding-gap saving. And the clamping force increases 15% compared to 1st generation.

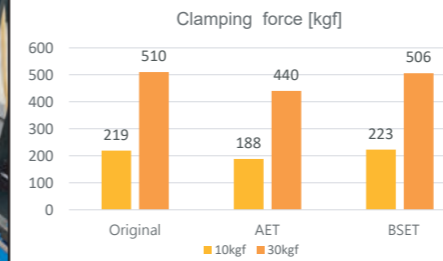

* Adjustment Knob

Adjustment Knob with inner hex holes permits to speed the fitting of expanding size by cooperating with L-key.

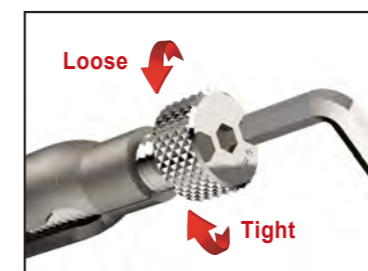

* Finest Holding Dimension

After constant improvement for BSET series, the strengthened construction of holding dimension is up to 20% decrease which enhances the safety for one-hand usage, no matter for small hand or big hand users. And this upgraded feature would expand the customer base.

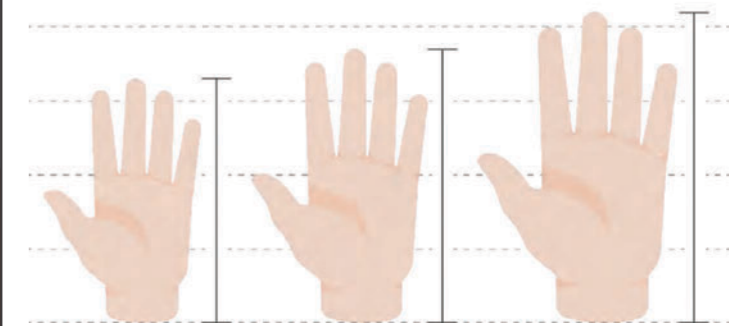

Small size
<175mm

Medium size
175~190mm

Big size
>190cm

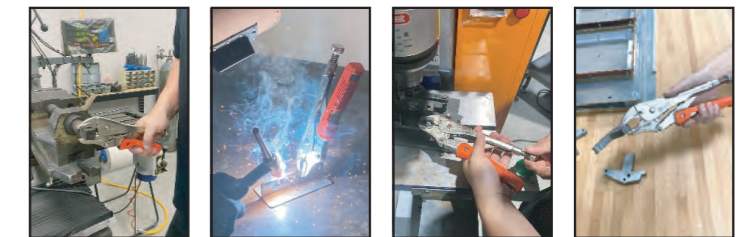

BSET Series Locking Pliers



Finish: Nickel Plated
Materials: Jaw & Handle - Chrome Molybdenum

Easy Release Style



Color options

Item No.	in / mm	mm	g
310BSET	10" / 250	53	590

Automatic Locking Pliers

No bolt adjustment.



● PATENTED MECHANISM DESIGN

Quickly self-adjust and lock on to thick and thin objects without turning the screw.

● 7x FASTER

7 times faster and way easier than traditional locking pliers.

● 2x STRONGER

Features the same heavy-duty construction as standard locking pliers.

● 100% EASY

Lock automatically without bothering to adjust the jaw opening.

● OPTIONAL ACCESSORIES

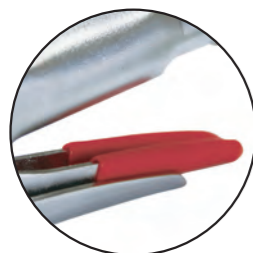

Color options

Release Lever Grip

The soft grip provides comfort and avoids slip while pulling the release lever. Optional color to customize your own style.

The special mechanism design allows you to simply squeeze the handle to clamp and lock the working pieces without bothering to adjust the jaw opening! And just pull the release lever to loosen. It's faster and easier than traditional locking pliers.

* Strong Hardened Jaws

Jaws are made of high-grade Chrome Vanadium alloy steel gives you maximum durability and increased gripping power and strength.

Curved jaw with serrated teeth can provide strong bite to hex, bolt, nuts, pipes, tubs and etc. It can also clamp two objects together to weld, nail, adhesive and so on.



* Patented mechanism design

The patented mechanism locking system allows the pliers automatically adjust the jaw's opening. So the automatic locking grip can provide a strong grip on your working pieces automatically without adjusting the opening width of the jaw.

* Pressure setting

The knurling tension screw can easily set desired clamp pressure from slight to extreme depending on your needs. Simply turn clockwise to increase the gripping pressure and turn counterclockwise to decrease.

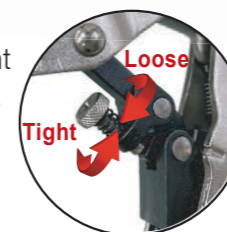

* Squeeze the handle to clamp and lock

No need to turn the adjusting screw! Just squeeze the handle directly to clamp and lock your working pieces no matter they're thick or thin!



* Pull the Release Lever to loosen

Simply pull the release lever upwards motion to loosen the bite quickly and easily and straight to move on to your next work directly without readjusting jaw opening even if the thickness of workpiece is different.



The automatic locking pliers have tons of uses and are transformers. It can be an adjustable wrench, pipe wrench, clamp pliers, wire cutter, portable vice and etc. One tool for all!!

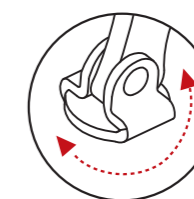

Constructed with swivel pads allows to clamp the objects without leaving scratch on the delicate surface.



Automatic Locking Pliers

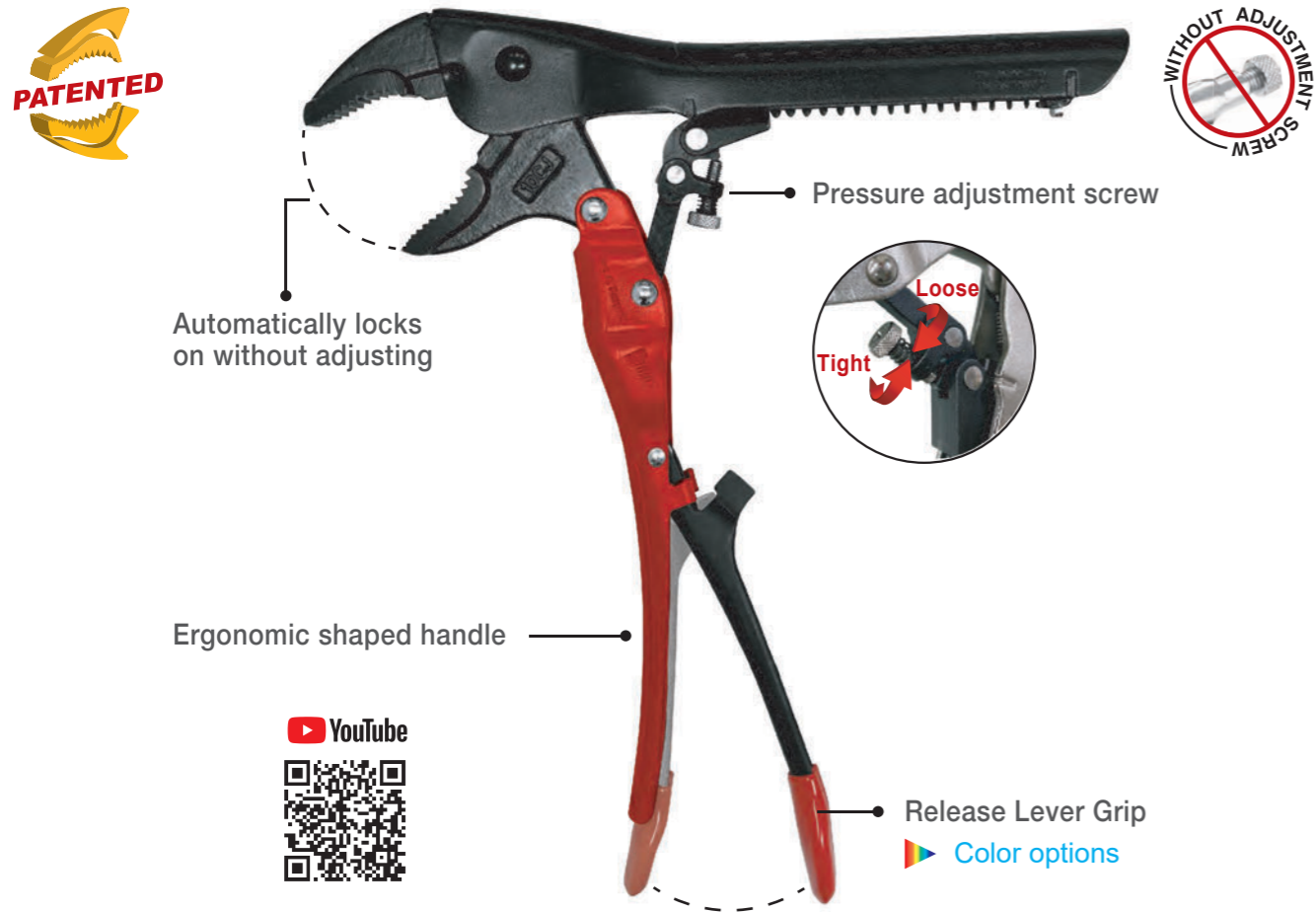

Automatic Curved Jaw Locking Pliers



With Wire Cutter

The automatic curved jaws automatically lock any size without adjustment. It's faster and easier than traditional locking pliers. Easy to squeeze the release lever, making it easier to release the pliers without damaging your knuckles.

Finish: Nickel Plated
Materials: Jaw - Chrome Vanadium / Handle - Carbon Steel

Item No.	in / mm	mm	g
T305A	6" / 150	31	240
T308A	8" / 220	40	540
T310A	10" / 250	48	620

Automatic Straight Jaw Locking Pliers

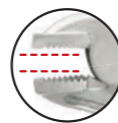

Straight Jaw

The jaws automatically lock any size without adjustment, and maintain the highest tip pressure. Self-adjusting locking pliers provide the versatility of a standard locking pliers.

Finish: Nickel Plated
Materials: Jaw - Chrome Vanadium / Handle - Carbon Steel

Item No.	in / mm	mm	g
T308RA	8" / 220	40	560
T310RA	10" / 250	48	630

Automatic Long Nose Jaw Locking Pliers

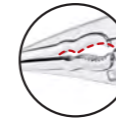

With Two Diameter

It's faster and easier than traditional locking pliers. The extended jaw rivet provides increased tip pressure at the same hand force. This pliers has the same heavy construction as standard locking pliers. There are hundreds of uses for this tool, such as adjustable wrenches, pipe wrenches, pliers, wire cutters and portable vices.

Finish: Nickel Plated
Materials: Jaw - Chrome Vanadium / Handle - Carbon Steel

Item No.	in / mm	mm	mm	g
T306A	7" / 175	51	4.5 / 7	310

Automatic Welder's Grip Wrench



This automatic fork clamp is made of chrome-molybdenum steel for excellent durability. Its U-shaped jaws provide reliable work access and maintain good results when the welds are properly aligned. This locking mechanism allows the jaws to be automatically adjusted to any size for simple one-handed operation, whether the workpiece is thick or thin.

Finish: Nickel Plated
Materials: Jaw - Chrome Molybdenum / Handle - Carbon Steel

Item No.	in / mm	mm	mm	mm	g
T309RS	9" / 225	41	30	65	650

Automatic Locking C-Clamps



The jaws automatically lock any size without adjustment, and maintain the highest tip pressure. The mechanism allows you to set the required clamping pressure, from slight to extreme, the jaws are automatically adjusted to any size with the same clamping pressure. The clamp-free release lever remains locked until you release it.

Finish: Nickel Plated
Materials: Jaw - Chrome Vanadium / Handle - Carbon Steel

Item No.	in / mm	mm	mm	mm	g
T306RA	7" / 230	62	71	68	335
T309CR	10" / 290	112	71	129	390
T311RA	11" / 330	86	100	95	870
T318RA	19" / 455	220	107	269	1410

Automatic Locking C-Clamps

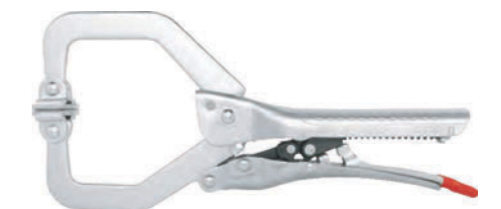

With Swivel Pads

The Locking C-Clamps feature wide open jaws and swivel pads for parallel clamping which prevent delicate surfaces from damage.

Finish: Nickel Plated
Materials: Jaw - Chrome Vanadium / Handle - Carbon Steel

Item No.	in / mm	mm	mm	mm	g
T306PA	7" / 230	62	70	58	370
T309CP	10" / 290	112	70	120	425
T311PA	11" / 330	86	100	85	920
T318PA	19" / 455	220	107	250	1460

Automatic Screw Removal Locking Pliers

Clamping without adjustment, it's faster and apter.



- 2-Step operation only
- 75% Timesaving
- Extremely versatile tool

The patented mechanism locking system allows the pliers automatically adjust the jaw's opening. So the automatic locking grip can provide a strong grip on your working pieces automatically without adjusting the opening width of the jaw.



1 LOCK

2 TURN

3 DONE

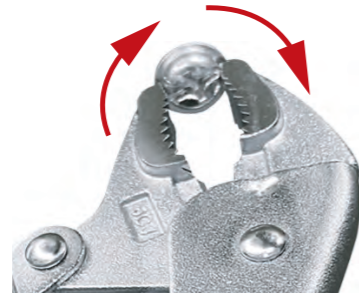

* Vertical serrations in the center

Pliers have specially shaped jaws with vertical and arch-lined serrations, which results in NO slippage when twisting the screw out.



* Grip & remove a stuck screw

The unique tip shape also supports low-head screws (truss screws). Since the vise mechanism grabs and locks the screw, even a tightly tightened screw can be turned with less force.

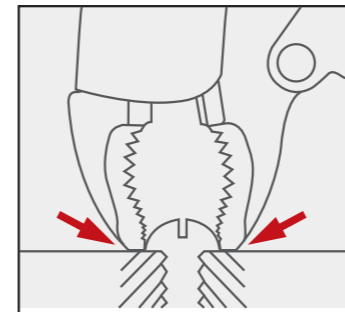

The vertically-serrated gripping surface holds screws firmly and securely for problem-free extraction.

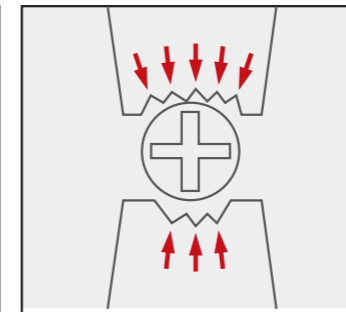

Specially-designed teeth generate gripping power, so no slippage.

* Pull the Release Lever to loosen

Simply pull the release lever upwards motion to loosen the bite quickly and easily and straight to move on to your next work directly without readjusting jaw opening even if the thickness of workpiece is different.



* Pressure setting

The knurling tension screw can easily set desired clamp pressure from slight to extreme depending on your needs. Simply turn clockwise to increase the gripping pressure and turn counterclockwise to decrease.

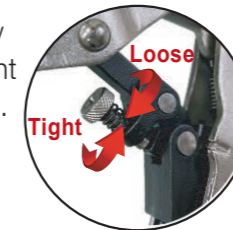

* Multi-functional tool

Curved jaw with serrated teeth can provide strong bite to hex, bolt, nuts, pipes, tubs and etc.

It can be used to fix various workpieces by adjusting the opening width. Protects the workpiece from twisting or slipping.

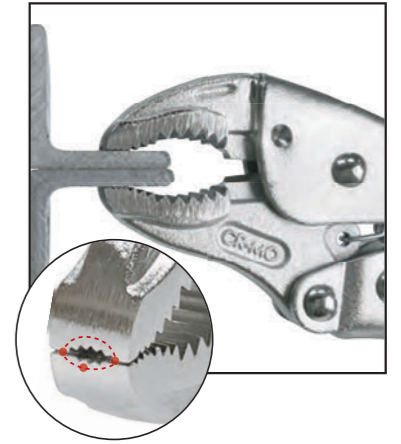

Automatic Screw Removal Locking Pliers



With Wire Cutter

Ideal for removing broken screws and for fixing various types of workpieces, etc.

Finish: Nickel Plated
Materials: Jaw - Chrome Vanadium / Handle - Carbon Steel

Item No.	in / mm	mm	mm	g
T305M	6" / 150	31	Φ 3-9.5	240
T310M	10" / 250	48	Φ 10-24	620

mm * Screw Head Size: Dome (Truss) Head, Round or Pan Head



- (1). The tool may not remove specially-hardened, heat-treated or glued screws.
- (2). Be sure to apply this tool to a screw head, but not to screw thread.

Screw Removal Locking Pliers

Simply grip the screw head & twist it out.



YouTube



Color options



The screw removal locking pliers have been specially designed to Vise-type screw removal locking pliers that bite the screw head firmly and does not allow it to slip. Just grip the screw head & twist it out.

These pliers have an unique jaw serration design (with the grooves arranged both horizontally & vertically) which ensures a firm grip on the screw.

* Vertical serrations in the center

Pliers have specially shaped jaws with vertical and arch-lined serrations, which results in NO slippage when twisting the screw out.



* Grip & remove a stuck screw

The unique tip shape also supports low-head screws (truss screws).

Since the vise mechanism grabs and locks the screw, even a tightly tightened screw can be turned with less force.



* Multi-functional tool

Curved jaw with serrated teeth can provide strong bite to hex, bolt, nuts, pipes, tubs and etc. It can be used to fix various workpieces by adjusting the opening width.

Protects the workpiece from twisting or slipping.

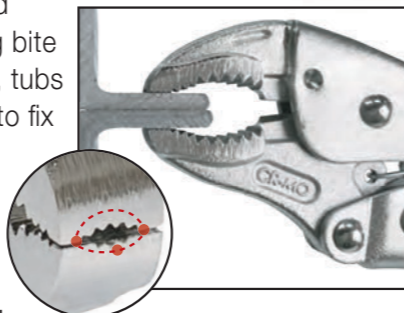

* Adjustment Knob

Knob with knurling texture allows to adjust the jaw capacity and locking pressure easily even wearing gloves or having slippery hands. Screw in to increase the pressure or enlarge the jaw size. Can be retightened with a hex key wrench.

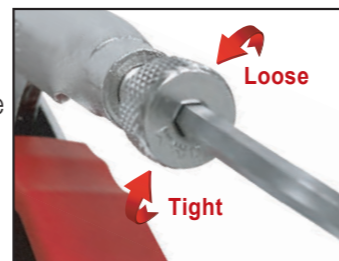

* Easy release handles

Easy Release type of handle allows to simply squeeze the handle to lock and pull away the handle to loosen. (allows one-handed operation) Optional color to customize your own style.

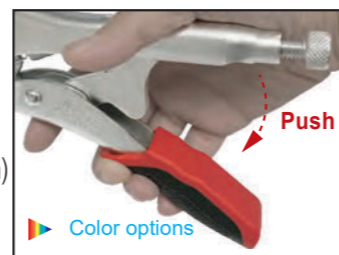

Screw Removal Locking Pliers



With Wire Cutter

Ideal for removing broken screws and for fixing various types of workpieces, etc.

Finish: Nickel Plated

Materials: Jaw & Handle Chrome Molybdenum

Easy Release Style



Color options

Item No.	in / mm	mm	mm	g
305MET	5" / 125	26	Ø 3-9.5	200
307MET	7" / 175	41	Ø 7-12	385

mm * Screw Head Size: Dome (Truss) Head, Round or Pan Head

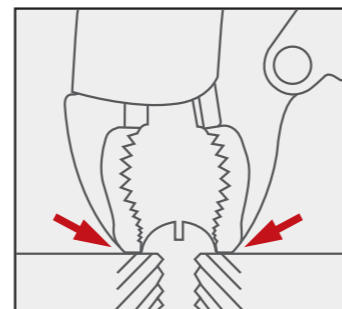

The vertically-serrated gripping surface holds screws firmly and securely for problem-free extraction.

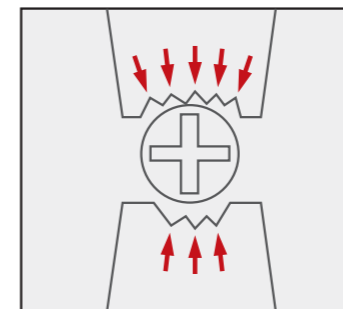

Specially-designed teeth generate gripping power, so no slippage.



(1) The tool may not remove specially-hardened, heat-treated or glued screws.

(2) Be sure to apply this tool to a screw head, but not to screw thread.

HOW TO USE



● **Step 1** : Loosen the adjusting screw to make the jaws fitting the diameter of screw.

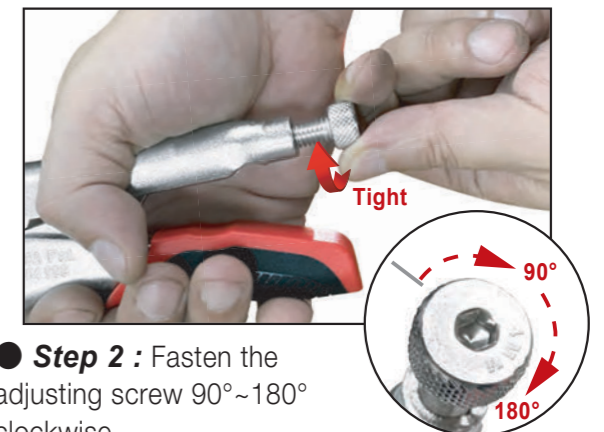

● **Step 2** : Fasten the adjusting screw 90°~180° clockwise. (Half a turn to the right)

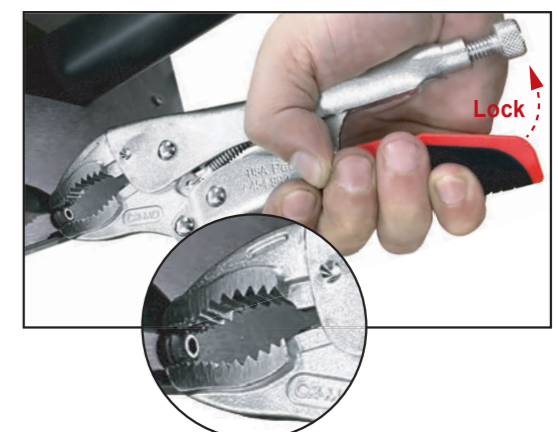

● **Step 3** : Squeeze the handles to lock the jaws. Turn and loosen the screw.

Grip Wrenches

Make welding easier.



Multifunctional tool with functions such as adjustable wrench, pliers and vise. Suitable for bending, forming and crimping metal sheets, convenient for light work such as temporary holding, fixing, welding, and joining fixtures, such as plating, welding, and factory maintenance! Ideal for welding work and rivet work.

● **2-in-1 feature**

Can be used as both a vise and pliers.

● **Single-handed operability**

The pliers clamp independently and set workpiece in place.

● **Perfect handling**

The opening width is regulated by the adjusting screw.

● **Maximum power**

High level of tension thanks to the toggle lever transmission.



Bottom jaw slides in a straight-line motion to hold penal in place when locking.

Locking Panel Clamps

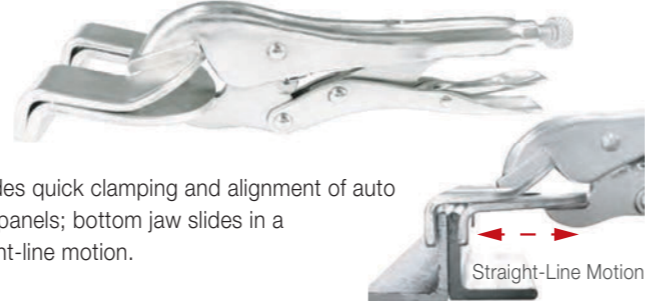

Provides quick clamping and alignment of auto body panels; bottom jaw slides in a straight-line motion.

Finish: Nickel Plated
Materials: Jaw & Handle - Chrome Molybdenum

American Style

Item No.	in / mm	mm	mm	mm	g
309USR	9" / 225	10	68		570

Welder's Grip Wrenches



U-shaped jaws provide enhanced visibility and more working space. For use in welding applications or for holding awkward shapes in place. Great for welding applications and holding unusual shapes in place.



Finish: Nickel Plated
Materials: Jaw & Handle - Chrome Molybdenum

American Style

Item No.	in / mm	mm	mm	mm	g
309RS	9" / 225	45	66	69	650
309RAI	11" / 275	52	70	69	815

European Style

Item No.	in / mm	mm	mm	mm	g
309RSE	9" / 225	45	66	69	650
309RAIE	11" / 275	52	70	69	815

Easy Release Style

Item No.	in / mm	mm	mm	mm	g
309RSAET	9" / 225	45	66	69	700
309RAET	11" / 275	52	70	69	865



The over-reaching split upper jaw let you clamp pieces in place and still have room to weld or at least firmly tack them in place for full welding later.

Welder's Grip Wrenches Pipe Working

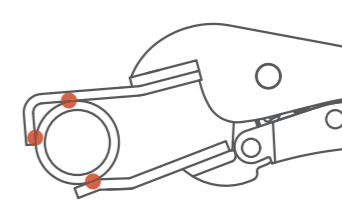

U-shaped clamping jaws, the upper jaws have V-profile to give secure three-point contact when clamping pipes. For clamping tubes and round stock when welding.

Finish: Nickel Plated
Materials: Jaw & Handle - Chrome Molybdenum

American Style

Item No.	in / mm	mm	mm	mm	g
309RXAI	11" / 275	75	75	68	855

European Style

Item No.	in / mm	mm	mm	mm	g
309RXAIE	11" / 275	75	75	68	855



Grip Wrenches

Sheet Metal Grips



Sheet Metal Grips, use the original locking metal plate to tighten the lock for a secure fixture tooling, and bend and crimp the metal plate for easy and precise operation.

Finish: Nickel Plated
Materials: Jaw & Handle - Chrome Molybdenum



American Style



Item No.	in / mm	mm	mm	g
308RS	8" / 200	39	79.5	510
308RAI	10" / 250	45	79.5	660

European Style



Item No.	in / mm	mm	mm	g
308RSE	8" / 200	39	79.5	510
308RAIE	10" / 250	45	79.5	660

Easy Release Style



Item No.	in / mm	mm	mm	g
308RSAET	8" / 200	39	79.5	560
308RAET	10" / 250	45	79.5	710

Color options

Roofers Welder Grip Wrench



PVC Covered Soft Material

Roofers welder grip wrench, maximum toughness and durability. Turn the screw to adjust the pressure and work. Opening jaws provide greater versatility.

Finish: Jaw - Nickel Plated
W/PVC dipping
Materials: Jaw & Handle - Chrome Molybdenum

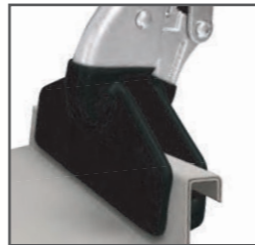

American Style



Item No.	in / mm	mm	g
308RST	8" / 200	7	600

European Style



Item No.	in / mm	mm	g
308RSTE	8" / 200	7	600



All surfaces in contact with the tray during seaming are protected by the PVC coating which guarantees a secure hold without damaging the material.

Pinch Off Pliers

Pinch off, lock on, and provide maximum locking force.



YouTube



Pinch Off Pliers

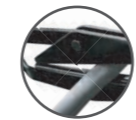

Swivel & Parallel Clamping

Unique design locks easily and automatically. Squeezing tight to lock and pulling the handle apart to unloose. Pinch-off pliers accept three different hose diameters for applying to different size of fuel lines, brake lines and vacuum hoses in cars, motorcycles and all kinds of engines.

Finish: Electric Black with red TPR grips
Materials: Jaw & Handle - Carbon Steel

Bent Handle Type

Item No.	in / mm	mm	g
405	4" / 140	20	75
409	8" / 225	35	330
413	12" / 325	70	540

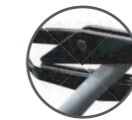

Swivel & Parallel Clamping



Finish: Electric Black with red TPR grips
Materials: Jaw & Handle - Carbon Steel

Straight Handle Type

Item No.	in / mm	mm	g
S405	4" / 145	20	70
S409	8" / 240	35	320
S413	12" / 365	70	540

Pinch Off Pliers

Hose Clamp Pliers



Mesh Jaws



The unique design of jaw is able to grab and lock various sizes of spring hose clamp! Make your repair work much easier and faster. Just squeeze to clamp, no adjustment needed. Superior quality and appealing design with a very competitive price.

Finish: Electric Black with red TPR grips
Materials: Jaw & Handle - Carbon Steel

Bent Handle Type

Item No.	in / mm	mm	g
405HCX	5" / 145	35	100
409HCX	9" / 235	55	305



Mesh Jaws



Finish: Electric Black with red TPR grips
Materials: Jaw & Handle - Carbon Steel

Straight Handle Type

Item No.	in / mm	mm	g
S405HCX	5" / 150	35	100
S409HCX	9" / 240	55	310

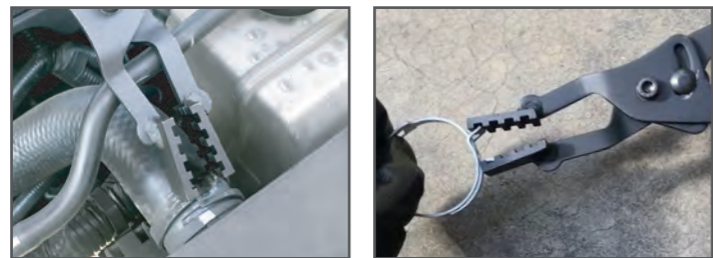

Pinch Off Locking Pliers



Copper Tubing



This locking pinch-off tool clamps and locks the copper tubing so that both hands can freely do other work. The jaw opening and clamping pressure can be changed simply by turning the adjusting screw. It remains adjusted for reuse. A guaranteed release trigger helps keep working safely. It will be released and unlocked quickly when needed. The locking clamp has a very powerful locking mechanism.

Finish: Nickel Plated
Materials: Jaw - Carbon Steel
Handle - Chrome Molybdenum

American Style

Item No.	in / mm	mm	g
307RR	7" / 175	29	360

European Style

Item No.	in / mm	mm	g
307RRE	7" / 175	29	360



Plastic Tubing



American Style

Item No.	in / mm	mm	g
510RR	10" / 250	35	530

European Style

Item No.	in / mm	mm	g
510RRE	10" / 250	35	530

Straight Nose Hose Pinch Pliers



Without Wire Cutter



The sloping head design allows direct access to the hose in a confined space. By using this straight nose hose pinch pliers, you can squeeze a hose to limit the liquid, water, oil...etc. inside, and continue to do the extra process. A rounded nose contour prevents damage to the hose, and don't need to worry about causing any scratch or mark on your hose. The jaw opening and clamping pressure can be changed simply by turning the adjusting screw. It remains adjusted for reuse. A guaranteed release trigger helps keep working safely. It will be released and unlocked quickly when needed.

Finish: Nickel Plated
Materials: Jaw & Handle - Chrome Molybdenum

American Style

Item No.	in / mm	mm	mm	mm	g
309RR	11" / 275	114	123	80	440

European Style

Item No.	in / mm	mm	mm	mm	g
309RRE	11" / 275	114	123	80	440

Angle Nose Hose Pinch Pliers



PATENTED



Without Wire Cutter

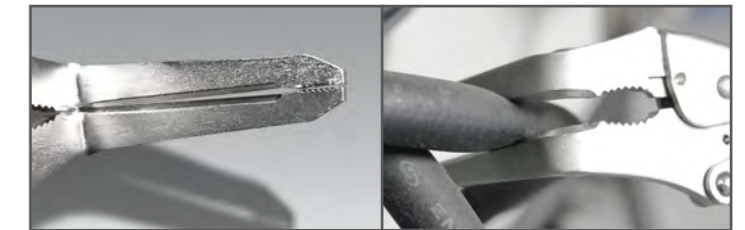

Angled head design allows for right angle access to hoses in tight spaces where straight access is limited, and the needle nose tip for accessing hard to reach hose clamps.

Finish: Nickel Plated
Materials: Jaw & Handle - Chrome Molybdenum

American Style

Item No.	in / mm	mm	mm	mm	g
309LR	11" / 275	43	123	80	435

European Style

Item No.	in / mm	mm	mm	mm	g
309LRE	11" / 275	43	123	80	435

Expanding Locking Pliers

Extending the achievement!



YouTube



Made of heat treated alloy steel for strength and durability. Unique reverse-action pliers are design to push objects in opposite directions, making them great for tasks like separating pieces that are stuck together, unbending, fitting tight parts, or bracing objects in place while glue dries.

* Jaw supply steady expanding power

Flexible expanding size setting by expanding screws and locking nut allows various expanding actions.

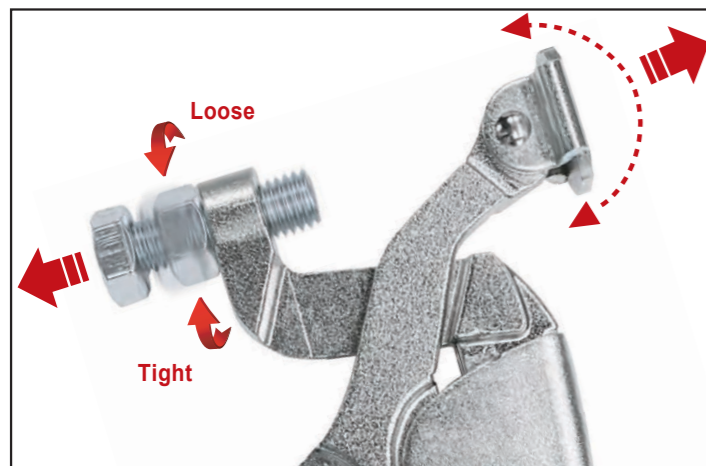

* Clamp around odd or awkward shaped items

Hold two workpieces, or a group of materials securely in place while you welding.

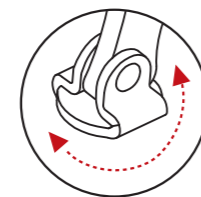

* Swivel Pads with Smooth Teeth

Constructed with flexible swivel pads with smooth teeth provides extra holding power which protects the working pieces.

* Adjustment Knob

Adjustment Knob with inner hex holes permits to speed the fitting of expanding size by cooperating with L-key.

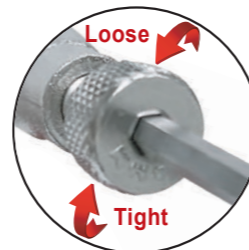

Expanding Locking Pliers



With Swivel Pads

Flexible expanding size setting allows various expanding actions. The jaws move in opposite directions to push against two objects.

Finish: Nickel Plated
Materials: Jaw & Handle - Chrome Molybdenum

American Style



Item No.	in / mm	mm	g
305XJ	5" / 125	23-45	225
307XJ	7" / 175	28-60	430
310XJ	10" / 250	33-76	650

European Style



Item No.	in / mm	mm	g
305XJE	5" / 125	23-45	225
307XJE	7" / 175	28-60	430
310XJE	10" / 250	33-76	650

Easy Release Style



Color options

Item No.	in / mm	mm	g
305XJAET	5" / 125	23-45	275
307XJAET	7" / 175	28-60	480
310XJAET	10" / 250	33-76	700

APPLICATION:

● Fit brackets

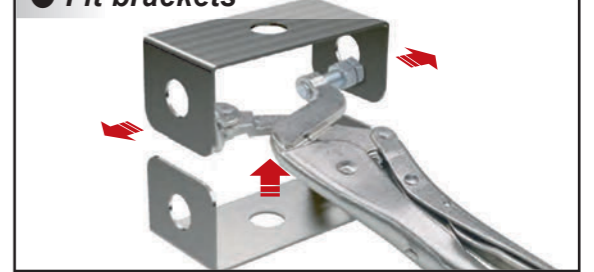

● Expanding works

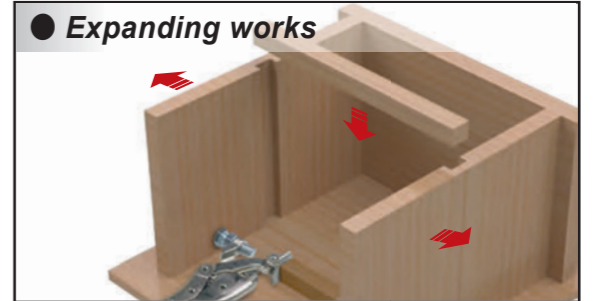

● Insert parts into U channel



● Break joints

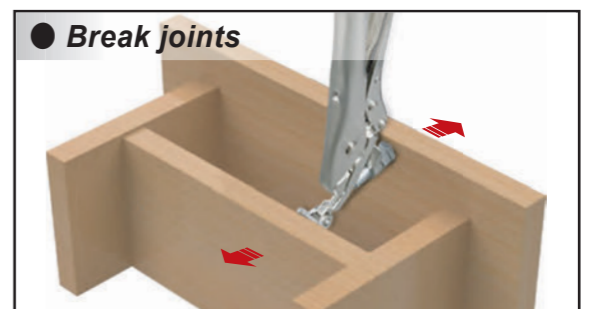

● Aim holes

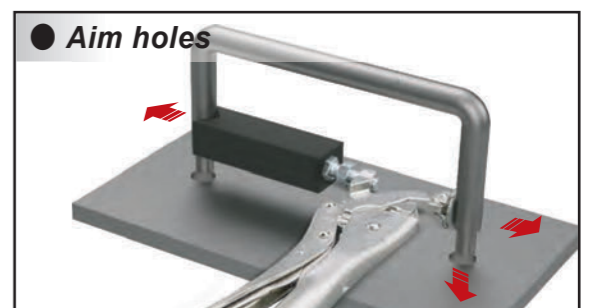

Locking C-Clamps

Wide and deep jaw provide greater versatility.



The wide opening jaws provide greater versatility to clamp various shapes of objects by adjusting screws. Classical trigger-release for maximum toughness and durability designed provides maximum locking force.

* Long Arms

This type of C-Clamp with special long arms allows to reach inner center of the working pieces.

* Strong Hardened Jaws

Jaws are made of high-grade Chrome Vanadium alloy steel gives you maximum durability and increased gripping strength.



* Wide jaw Capacity

The special design of the long arms provides wide jaw capacity which is able to clamp or hold thicker or larger objects while providing greater versatility.

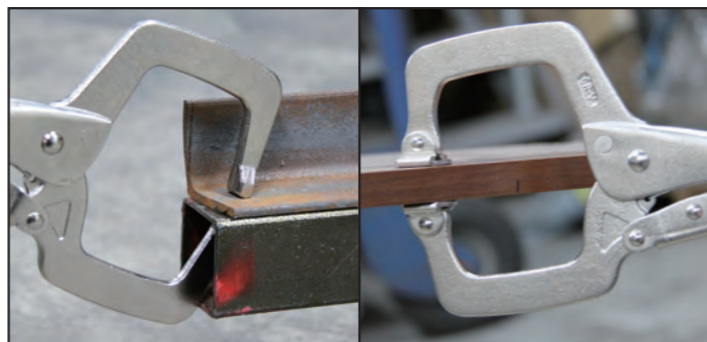
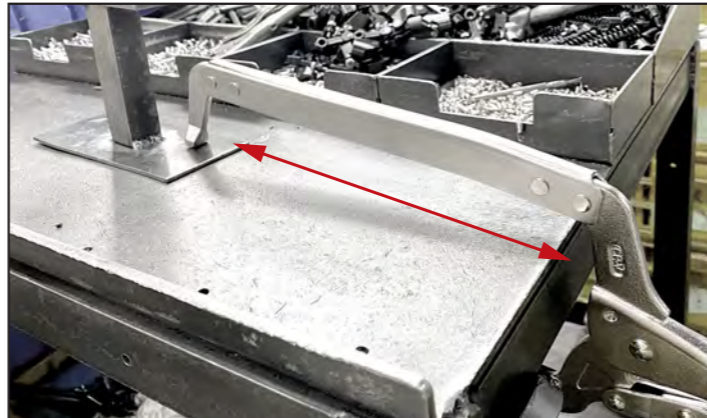

* Swivel Pads with Smooth Teeth

Constructed with flexible swivel pads with smooth teeth provides extra holding power which protects the working pieces.

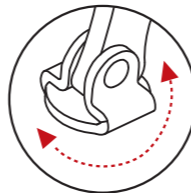

Stepped C-Clamps



With Swivel Pads

Three different consecutive capacities suit different workpiece sizes, and the swivel pads allow the user to use the tool for clamping delicate materials.



Finish: Nickel Plated
Materials: Jaw - Carbon Steel
Handle - Chrome Molybdenum

American Style



Item No.	in / mm	mm	mm	mm	g
5150	10" / 288	80~150	145	70	885
5230	10" / 288	150~230	210	70	1050
5300	10" / 288	230~300	295	70	1145

European Style



Item No.	in / mm	mm	mm	mm	g
5150E	10" / 288	80~150	145	70	885
5230E	10" / 288	150~230	210	70	1050
5300E	10" / 288	230~300	295	70	1145

Easy Release Style



Color options

Item No.	in / mm	mm	mm	mm	g
5150AET	10" / 288	80~150	145	70	935
5230AET	10" / 288	150~230	210	70	1100
5300AET	10" / 288	230~300	295	70	1195

Locking C-Clamps With PVC Covered

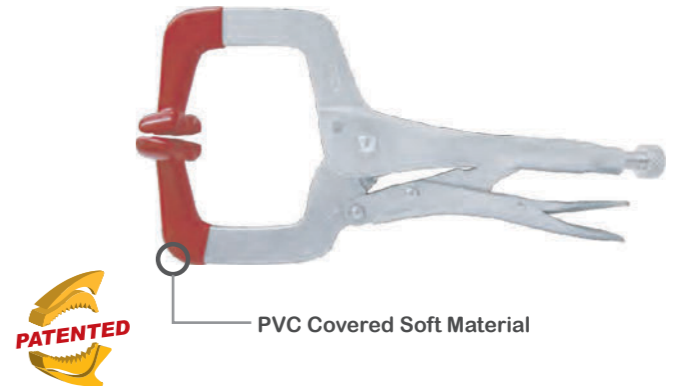

PVC Covered Soft Material

Locking C-Clamps feature wide open jaws and the pads with PVC covered, the soft materials prevents surface damage, ensures good working order and avoids tiresome cleaning.

Made from high-grade heat-treated alloy steel for maximum toughness and durability, these C-Clamps feature a classic trigger-release design that maintains maximum locking force.

Finish: Nickel Plated
Jaw with PVC dipping
Materials: Jaw - Chrome Vanadium
Handle - Chrome Molybdenum



American Style



Item No.	in / mm	mm	g
311DH	11" / 285	78	810



Locking C-Clamps

Locking C-Clamps



The wide opening jaws provide greater versatility to clamp various shapes of objects by adjusting screws. Classical trigger-release for maximum toughness and durability designed provides maximum locking force.

Finish: Nickel Plated
Materials: Jaw - Chrome Vanadium
Handle - Chrome Molybdenum

American Style

Item No.	in / mm	mm	mm	mm	g
306RAI	6" / 150	36	60	35	250
309CR	9" / 225	101	80	120	385
311RAI	11" / 275	88	90	75	765

European Style

Item No.	in / mm	mm	mm	mm	g
306RAIE	6" / 150	36	60	35	250
309CRE	9" / 225	101	80	120	385
311RAIE	11" / 275	88	90	75	765

Easy Release Style

Item No.	in / mm	mm	mm	mm	g
306RAET	6" / 150	36	60	35	300
311RAET	11" / 275	88	90	75	825

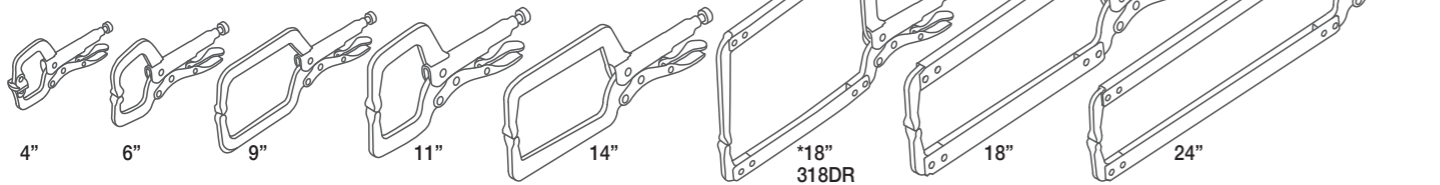

Finish: Nickel Plated
Materials: Jaw - Chrome Vanadium
Handle - Chrome Molybdenum
Extension bar - Chrome Molybdenum

American Style

Item No.	in / mm	mm	mm	mm	g
* 318DR	18" / 455	178	190	245	1420
318RAI	18" / 455	163	100	250	1210
324RAI	24" / 610	300	80	395	1500

*Special size, longer and wider

European Style

Item No.	in / mm	mm	mm	mm	g
* 318DRE	18" / 455	178	190	245	1420
318RAIE	18" / 455	163	100	250	1210
324RAIE	24" / 610	300	80	395	1500

*Special size, longer and wider

Easy Release Style

Item No.	in / mm	mm	mm	mm	g
318RAET	18" / 455	163	100	250	1270

Color options

Locking C-Clamps



With Swivel Pads

Use the rotating pad to lock the C-Clamp, with wide open jaws for more functionality and clamping of small objects with just one tool. The pressure and fit can be adjusted by turning the screw and the rotary screw can be used repeatedly. Made from high-grade heat-treated alloy steel for maximum toughness and durability, these small C-Clamps feature a classic trigger-release design that maintains maximum locking force.

Finish: Nickel Plated
Materials: Jaw - Chrome Vanadium
Handle - Chrome Molybdenum

American Style

Item No.	in / mm	mm	mm	mm	g
304PAI	4" / 100	26	45	25	145
* 306PAI	6" / 150	36	60	35	280
* 309CP	9" / 225	88	80	110	415
311PAI	11" / 275	89	90	75	815
314PAI	14" / 355	110	90	150	980

*Jaw Materials: Chrome Molybdenum

European Style

Item No.	in / mm	mm	mm	mm	g
304PAIE	4" / 100	26	45	25	145
* 306PAIE	6" / 150	36	60	35	280
* 309CPE	9" / 225	88	80	110	415
311PAIE	11" / 275	89	90	75	815
314PAIE	14" / 355	110	90	150	980

*Jaw Materials: Chrome Molybdenum

Easy Release Style

Item No.	in / mm	mm	mm	mm	g
* 306PAET	6" / 150	36	60	35	320
311PAET	11" / 275	89	90	75	850

*Jaw Materials: Chrome Molybdenum



With Swivel Pads

Finish: Nickel Plated
Materials: Jaw - Chrome Vanadium
Handle - Chrome Molybdenum
Extension bar - Chrome Molybdenum

American Style

Item No.	in / mm	mm	mm	mm	g
318PAI	18" / 455	208	90	240	1260
324PAI	24" / 610	304	80	405	1530

European Style

Item No.	in / mm	mm	mm	mm	g
318PAIE	18" / 455	208	90	240	1260
324PAIE	24" / 610	304	80	405	1530

Easy Release Style

Item No.	in / mm	mm	mm	mm	g
318PAET	18" / 455	208	90	240	1315

Color options

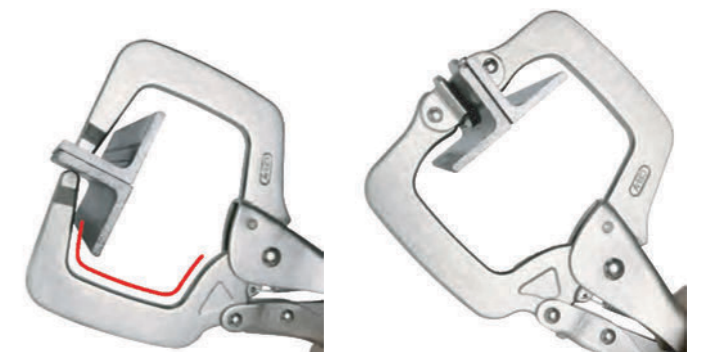

Swivel pads hold tapered work, awkward fabricating jobs, and delicate projects without damaging the work surface.

Locking C-Clamps EUR Series

Quick size adjusting, smart working!



Table C-Clamps are suitable for drilling objects on fixed drilling machines. The hole in the bottom of the tool allows for fixing to the machine T-slot or table, for drilling, light grinding, welding, bonding, engraving of the clamp parts, which can be securely locked or loosely connected to allow sliding and / or pivoting turn.

* Quick Size Adjusting

Flexible clamping size directly setting by adjusting bolts allows various clamping actions.



* Extreme Clamping Capacity

Constructed of heat-treated Chrome Molybdenum alloy steel gives maximum durability gripping power. Max. clamping capacity 70 ~150 mm.

* Swivel Pads with Smooth Teeth

Swivel pads with smooth pattern which provides stable horizontal clamping and extra holding power.

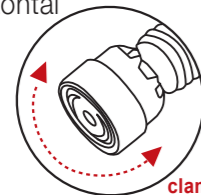

* Slim Profile

Slim profile allows to access in confined, narrow space.



Max. clamping capacity 70 ~150 mm



* U Shaped Arms

U shaped arms allow to clamp variety shapes materials while providing greater versatility. Suitable for welding, wood working, carpenter, engineer, and etc.



* Squeeze To Lock, Pull Up To Loosen

Unique design of European handle. Simply squeeze the handle to lock and pull up the release lever to loosen.

Table C-Clamps

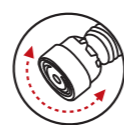

With Swivel Pads

European Style

Item No.	Length in / mm	Width mm	Depth mm	Weight g
403CL	8" / 195	70	30	710
403CLW	9" / 230	70	60	815
405CLW	9" / 230	150	60	970

*Optional finish: nickel plated, phosphate finish, and black liquid coating.

Table C-Clamps

Designed to mount directly to your workbench.



Table C-Clamps are suitable for drilling objects on fixed drilling machines. The hole in the bottom of the tool allows for fixing to the machine T-slot or table, for drilling, light grinding, welding, bonding, engraving of the clamp parts, which can be securely locked or loosely connected to allow sliding and / or pivoting turn.

* Ø12.5mm Holes in base of tool

Allows fixing on machinery T-Slots or on tables & work benches.



* 4 arm sizes

The clamping range is from 75~150mm, and the clamping depth of the workpiece is deep.



Example is Replaceable Table C-Clamps.

* Adjustment Knob

Knob with knurling texture allows to adjust the jaw capacity and locking pressure easily even wearing gloves or having slippery hands. Screw in to increase the pressure or enlarge the jaw size. Can be retightened with a hex key wrench.

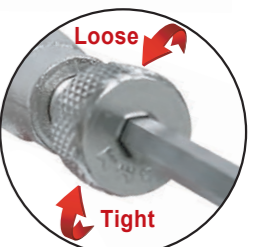

* Push the release lever up to release

Just push the release lever up to quickly release And it's easy.



* Swivel Pads with Smooth Teeth

Constructed with flexible swivel pads with smooth teeth provides extra holding power while protecting the working pieces.

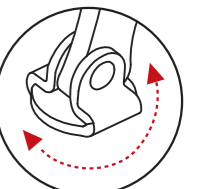

Plier Set



6pc Replaceable Table C-Clamps Set



With Swivel Pads



This Replaceable Table C-Clamps kit comes packaged in a blow molded case, With 4 arms of different lengths.

Finish: Nickel Plated
Materials: Jaw & Handle - Chrome Molybdenum



Item No.	6pc Replaceable Table C-Clamps Set	1720
10PL Jaw	x1 (Opening 90mm, Throat Depth 80mm)	
11PL Jaw	x1 (Opening 80mm, Throat Depth 75mm)	
*11RL Jaw	x1 (Opening 75mm, Throat Depth 75mm)	
14PL Jaw	x1 (Opening 120mm, Throat Depth 150mm)	
10" Handle Set	x1	
Accessory Set	x1 (Spring x2, Base x3, Screw Set x1)	

*Not with swivel pads.

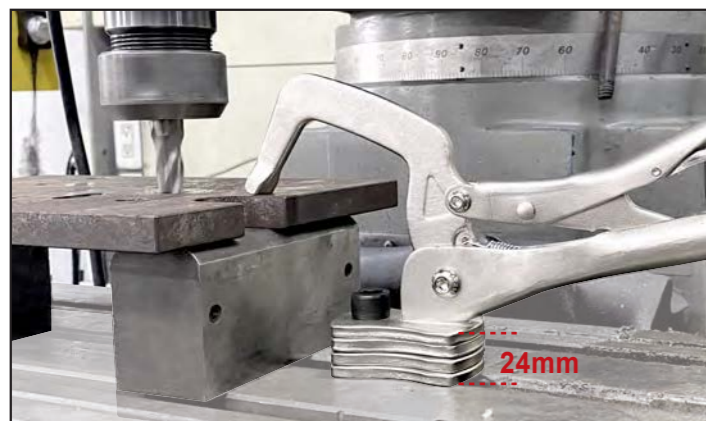

The height of base can be increased up to 24mm.



You can use a hex key wrench or an open-end wrench to tighten the screws.

ASSEMBLY INSTRUCTION

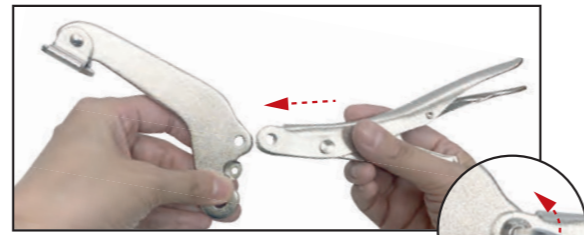

● **Step 1 :** Assemble the handle and replacement jaw with one screw. It is recommended to use a hex key wrench 4 mm or an open end wrench 10 mm to tighten the screws.



● **Step 2 :** Hook the spring on the hole of jaw part. And clasp the end ring of spring on the lower handle.



● **Step 3 :** The locking pliers could be workable without spring. Spring assembled will make the lower handle return automatically and work more efficiently.

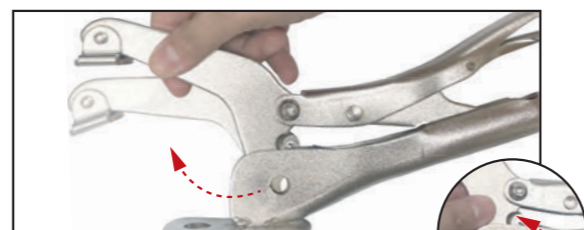

● **Step 4 :** Finally, fix the assembled replaceable jaw and handle base with one screw. It is recommended to use a hex key wrench 5 mm or an open end wrench 13 mm to tighten the screws.

Table C-Clamps



With Swivel Pads

Finish: Nickel Plated
Materials: Jaw & Handle - Chrome Molybdenum

American Style



Item No.	in / mm	mm	mm	g
311HM	11" / 275	90	80	650
311PHM	11" / 275	80	75	700
314PHM	14" / 355	120	150	790



Smooth jaws provide a strong force at the tip to hold tapered work, awkward materials and delicate projects without damaging its surface.

Finish: Nickel Plated
Materials: Jaw & Handle - Chrome Molybdenum

American Style



Item No.	in / mm	mm	mm	g
311RHM	11" / 275	75	75	690

- Can be quickly mounted and dismantled on welding table.
- Clamp or hold your working pieces in your desired place.
- Suitable for metal work, welding, soldering, metal processing, wood working and etc.

T-Slot Clamp With Pipe



With Swivel Pads

Finish: Nickel Plated
Materials: Jaw & Handle - Chrome Molybdenum

American Style



Item No.	in / mm	mm	mm	Depth in / mm	g
311HP	11" / 275	105	Ø 28	150	1020
311PHP	11" / 275	85	Ø 28	150	1070
314PHP	14" / 355	105	Ø 28	150	1160

Drill Press Clamp

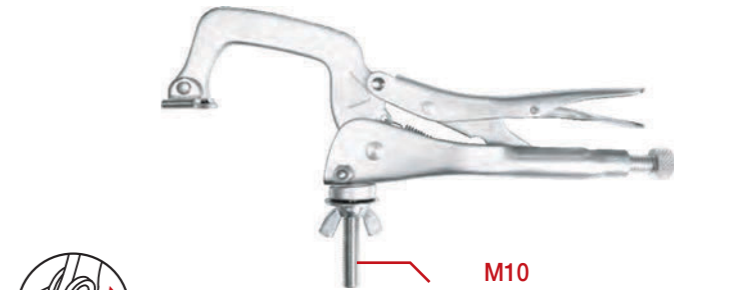

With Swivel Pads

Finish: Nickel Plated
Materials: Jaw & Handle - Chrome Molybdenum

American Style



Item No.	in / mm	mm	mm	Depth in / mm	g
311SHP	11" / 275	85	10	50	680

90° Corner Woodwork Clamp

Allow two wood block to be jointed at a 90 degree angle.



The 90° Corner Woodwork Clamp can be used for 90° corner joints and "T" joints together. It is perfect for aligning, woodworking, making cabinets and cases. It holds work pieces precisely and set up instantly.

*** Double "V" Keep 90°**
Outer "V" and inner "V" in order to hold those pieces at a 90° angle to one another.

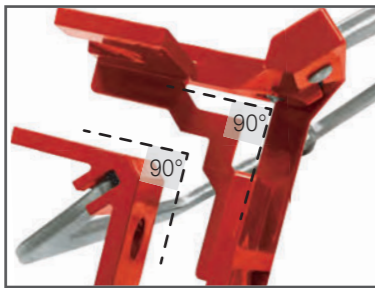

*** Quickly assemble and fix the 90° shelf**

Suitable for 90° angle and "T" shaped joints. Pull the drawer box into the aligned position quickly and easily.

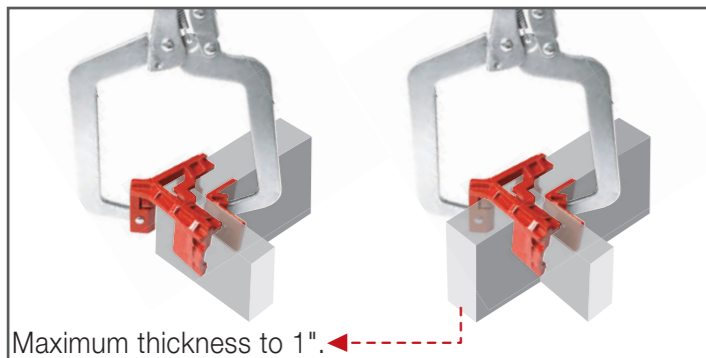

*** Two-way switching**
Patented strut can be flipped quickly and easily to work on next corner.

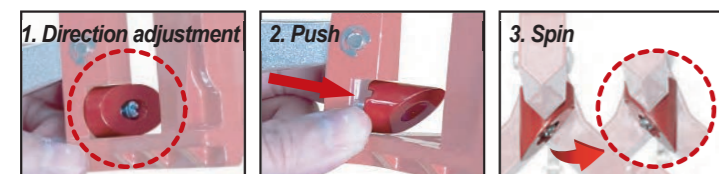

*** The Cutout allows to put pocket screw**

The cutout in the pads allows to put pocket screws in place without undoing the clamp.



90° Corner Woodwork Clamp

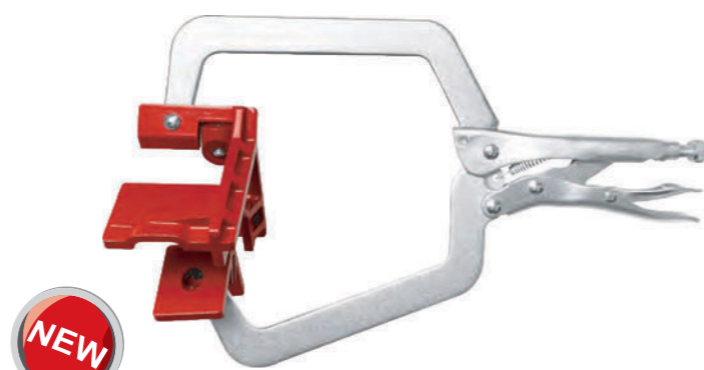

Finish: Jaw - Painting
Handle - Nickel Plated
Materials: Jaw - Aluminum
Handle - Chrome Molybdenum

American Style

Item No.	in / mm	Thickness	g
309CS	9" / 255	1" / 25.4	520

2-Way Right Angle Woodwork Clamp

One Clamp, Dual Purposes.



2-way right angle woodwork clamps, particularly suitable for drawer construction and shelf installation, help to fix components such as boxes, cabinets, drawers and cases, make your woodworking or DIY working hassle-free.

*** Strong Adjustable Clamping Force**

This clamp can work as Right Angle Clamp & C-Clamp. The steel pin on this clamp is shaped to fit snugly into a pocket hole, securely anchoring one workpiece against the other for easy assembly.

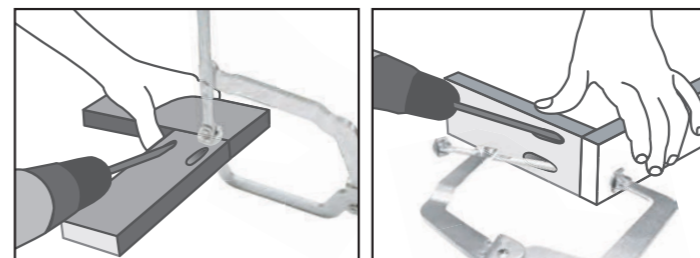

*** Swivel Pads with Smooth Teeth**

Constructed of flexible swivel pads with smooth teeth provides extra holding power while protecting the working pieces.

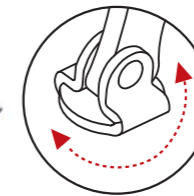

*** Multi-purpose 90°**

2-way clamps can work as right angle clamps or c-clamps, which keep pocket holes secure and square at 90° degrees during project assembly and effective clamping.



2-way right angle woodwork clamp

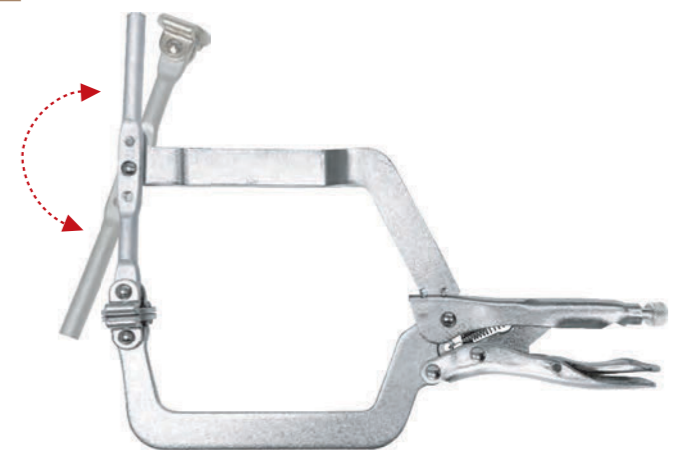

Finish: Nickel Plated
Materials: Jaw & Handle - Chrome Molybdenum

American Style

Item No.	in / mm	mm	Depth in / mm	g
309TF	9" / 250	38-65	2" / 50	450

Axial Welding Pliers

One-hand easy as clamp, weld, release!



YouTube



Color options

Axial welding pliers make and secure joint welding for workers.

This welding pliers come with 6 different axial jaws. Each plier allows clamping of different types of joints, to fit and operate in tight, narrow, and hard to access spaces. They are released with one-handed buttons and are made of durable forged heat-treated steel.

* Press the Release Button to loosen

Simply press the release button to loosen quickly and easily.



* Pressure setting

Knurled screw can easily set desired clamp pressure from slight to extreme according to your needs. Simply turn clockwise to increase the gripping pressure and turn counterclockwise to decrease.



Plier Set



6pc Axial Welding Pliers Set



This welding clamp pliers kit comes packaged in a blow molded case with 6 different axial jaw. Each plier allows for clamping different types of set joints.

Finish: Nickel Plated / Electro-Black
Materials: Jaw & Handle - Chrome Molybdenum

Item No.	6pc Axial Weld Bonding Pliers Set	3600
528W	W-Type	
518T	T-Type	
525JJ	JJ-Type	
522J	J-Type	
515LL	LL-Type	
512L	L-Type	

Plier Type



528W Self-locking multi-grip plier Wide flat jaws



Clamp a lap joint allowing 4 consecutive spot welding without tool removal.

Finish: Nickel Plated / Electro-Black
Materials: Jaw & Handle - Chrome Molybdenum

Item No.	in / mm	mm	g
528W	8" / 200	10	495

518T Self-locking multi-grip plier Flat jaws set at 90° angle



Clamp sheet metal pieces of equal thickness at 90°

Finish: Nickel Plated / Electro-Black
Materials: Jaw & Handle - Chrome Molybdenum

Item No.	in / mm	mm	g
518T	7" / 175	15	480

525JJ Self-locking multi-grip plier Double curved jaws

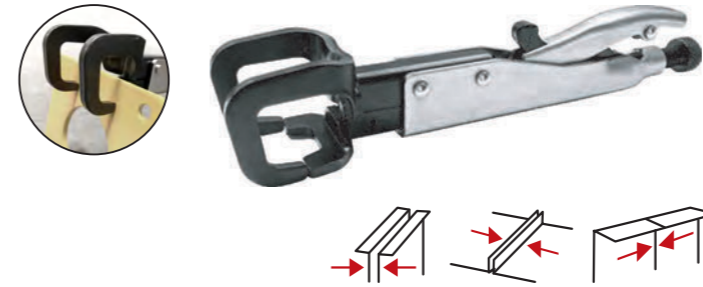

Clamp a flanged lap joint, butt joint or adjacent joint.

Finish: Nickel Plated / Electro-Black
Materials: Jaw & Handle - Chrome Molybdenum

Item No.	in / mm	mm	g
525JJ	9" / 225	10	520

522J Self-locking multi-grip plier Angled jaws

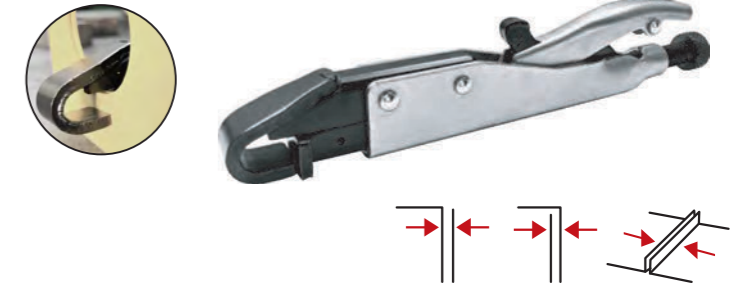

Clamp a single flanged lap joint or butt joint.

Finish: Nickel Plated / Electro-Black
Materials: Jaw & Handle - Chrome Molybdenum

Item No.	in / mm	mm	g
522J	8" / 200	10	440

515LL Self-locking multi-grip plier Wide curved jaws

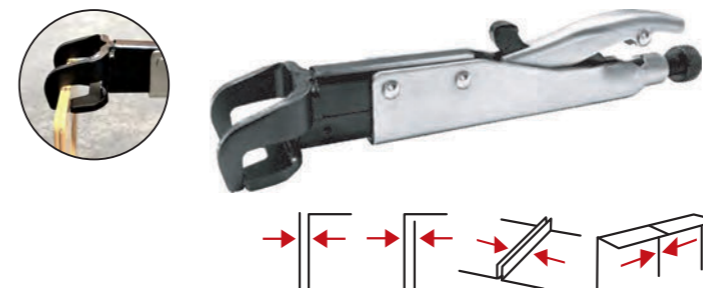

Clamp a single flanged lap joint, a butt joint or adjacent joint.

Finish: Nickel Plated / Electro-Black
Materials: Jaw & Handle - Chrome Molybdenum

Item No.	in / mm	mm	g
515LL	8" / 200	15	470

512L Self-locking multi-grip plier Straight jaws



Clamp a lap joint or butt joint, enabling small profile works through holes.

Finish: Nickel Plated / Electro-Black
Materials: Jaw & Handle - Chrome Molybdenum

Item No.	in / mm	mm	g
512L	7" / 175	15	430

French Type

Sliding & Adjustable Jaw Locking Pliers.



● FLEXIBLE WIDE OPENING ADJUSTMENT

4 slip joint positions to adjust the jaw capacity.

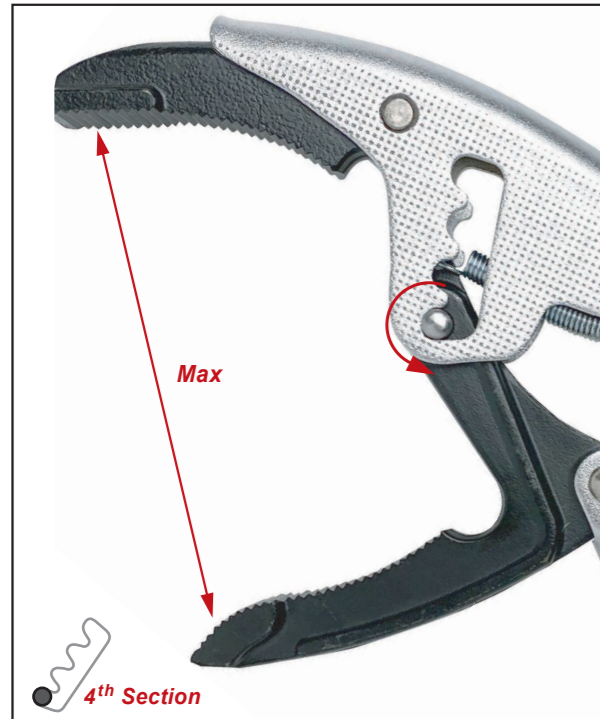
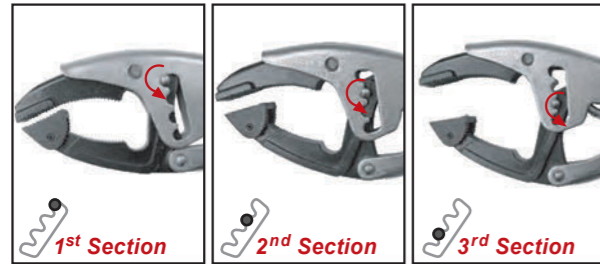

YouTube



4-Position slip joint for prompt adjustment of jaw capacity. One handed operation- Quick release system by release lever. Safety lock system to prevent accidental release. Knurled screw for precise jaw adjustment. Forged and hardened jaws with heavy duty grooves for consistent clamping.

* Press the Release Lever to loosen

Simply press the release lever upwards to loosen quickly and easily.



* Pressure setting

Knurled screw can easily set desired clamping pressure from slight to extreme according to your needs. Simply turn clockwise to decrease the gripping pressure and turn counterclockwise to increase.

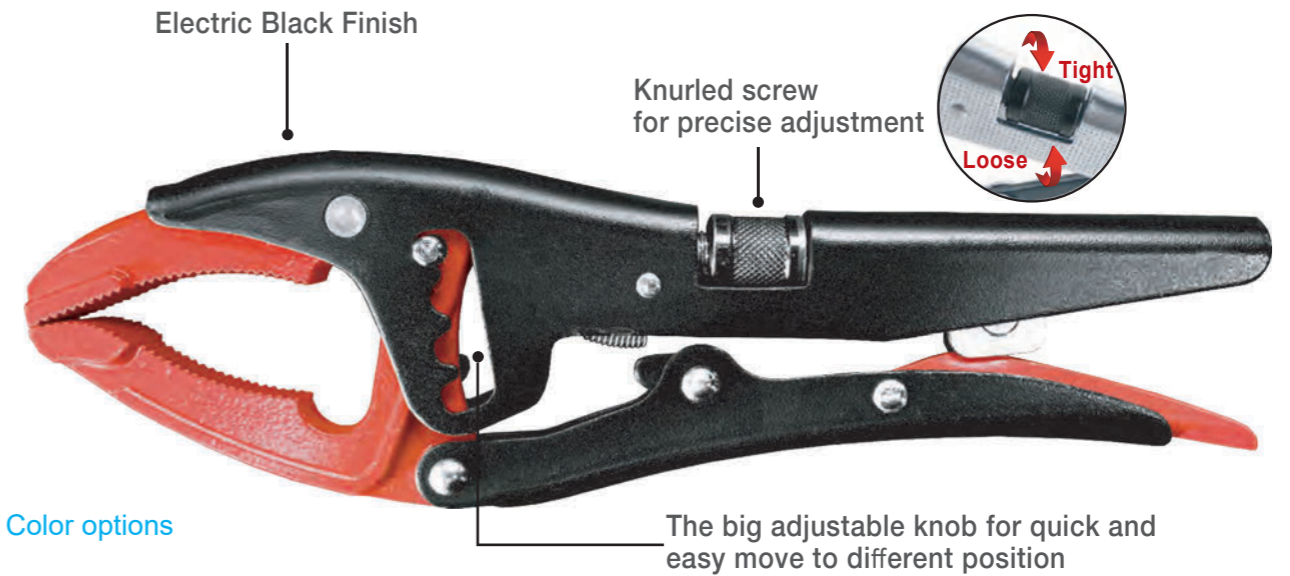
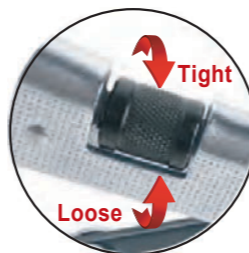

▶ Color options

French Type Adjustable Jaw Locking Pliers



4036 Straight Jaw



Finish: Chrome Plated
Materials: Jaw & Handle - Chrome Molybdenum

Item No.	in / mm	mm	g
4036	10" / 250	95	610

4037 Curved Jaw



Finish: Chrome Plated
Materials: Jaw & Handle - Chrome Molybdenum

Item No.	in / mm	mm	g
4037	10" / 250	80	715

4038 Curved Jaw with Swivel Pads

2 WAY



Finish: Chrome Plated
Materials: Jaw & Handle - Chrome Molybdenum

Item No.	in / mm	mm	g
4038	10" / 250	80	720

4139 Large Jaw

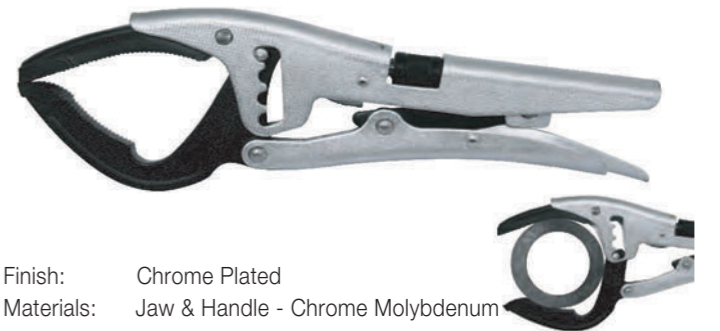

Finish: Chrome Plated
Materials: Jaw & Handle - Chrome Molybdenum

Item No.	in / mm	mm	g
4139	12" / 300	93	785

German Type

High clamping pressure due to toggle lever action.



Constructed of forged alloy steel for maximum durability. The streamline and ergonomic design provide both comfortability and aesthetic feeling. Finished in durable nickel plating to create a corrosion resistant coating. Special mechanism design provides a strong clamping force that stabilizes the working piece in desired position. This series includes variety of jaw types to satisfy your needs in clamping, gripping, or holding rods, tubes, pipes, metal sheets, adjacent joints, and tanks. Also suitable to tighten or loosen nuts, hexes or bolts, and use on metal work, welding, soldering, auto repair, maintenance, engineer, plumber, metal processing and etc.

* Adjustment Knob

Knob with knurling texture allows to adjust the jaw capacity and locking pressure easily even wearing gloves or having slippery hands. Screw in to increase the pressure or enlarge the jaw size. Can be retightened with a hex key wrench.

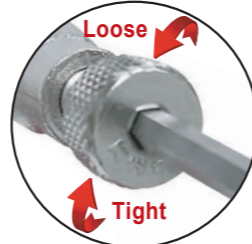

* Pull the Release Lever to loosen

Simply pull the release lever upwards motion to loosen the bite quickly and easily and straight to move on to your next work directly without readjusting jaw opening even if the works' thickness are different.



* Release lever options

The soft grip provides comfort and avoids slip while pulling the release lever. Optional color to customize your own style.

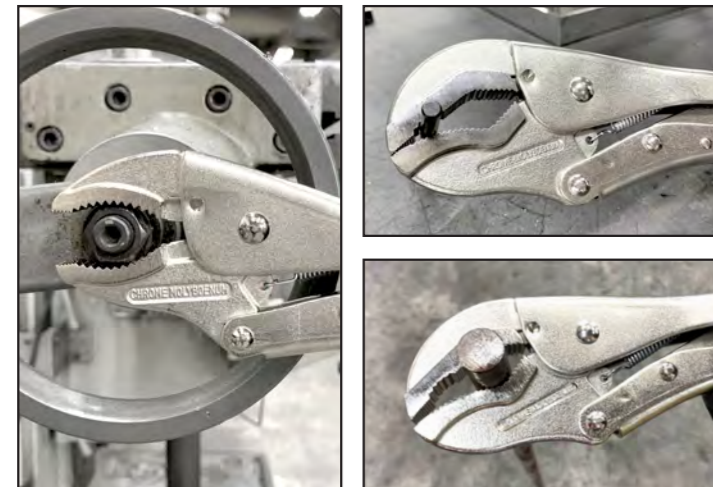
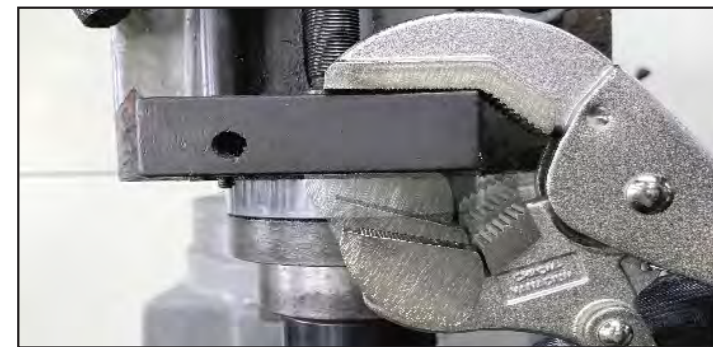
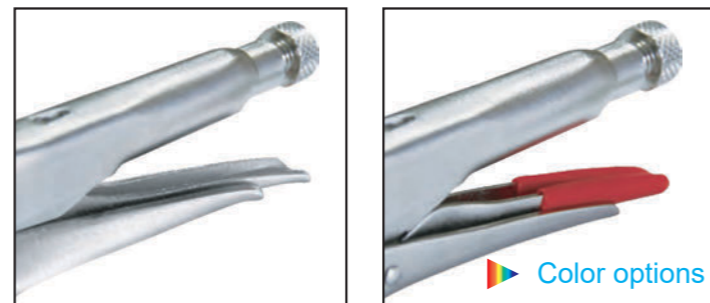

Curved Jaw German Type



With Wire Cutter

Half-round jaws, particularly suitable for round and flat material.

Finish: Nickel Plated
Materials: Jaw & Handle - Chrome Molybdenum

German Style

Item No.	in / mm	mm	g
310EASI	10" / 250	53	550
312EASI	12" / 300	70	950

V Jaw Locking Pliers



With Curved Lower Jaw

Especially suitable for round and flat material.

Finish: Nickel Plated
Materials: Jaw & Handle - Chrome Molybdenum

German Style

Item No.	in / mm	mm	g
307EEAIE	7" / 175	40	330
310EEAIE	10" / 250	43	515
312EEAIE	12" / 300	70	910

Parallel Plus Grip Pliers



YouTube



Combined jaw shape with a pivoting jaw. Fine serration in the anterior jaw area.

Finish: Nickel Plated
Materials: Jaw & Handle - Chrome Molybdenum

German Style

Item No.	in / mm	mm	g
310SWE	10" / 236	48	630

VVE Jaw Locking Pliers

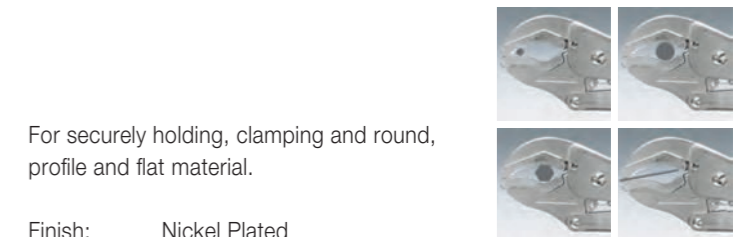

For securely holding, clamping and round, profile and flat material.

Finish: Nickel Plated
Materials: Jaw & Handle - Chrome Molybdenum

German Style

Item No.	in / mm	mm	g
310VVE	10" / 250	48	550

German Type

Angled Grip Wrench



With its non-serrated rear section has extremely diverse applications, such as clamping hoses (including water spray hoses and fuel hoses).



The long slim and serrated jaws, angled 70°, perfected for gripping and securing workpieces in tight, angled spaces, the handles do not obstruct the working area.

Finish: Nickel Plated
Materials: Jaw & Handle - Chrome Molybdenum

German Style					
Item No.	in / mm	mm	mm	mm	g
307SE	7" / 195	51			400

Welder's Grip Wrenches



U-shaped clamping jaws; upper jaw angled 90°. Wide opening jaws provide greater versatility. Suitable for bending, forming and crimping metal sheets, or fixed two pieces of metal, welding to create one solid continuous piece.

Finish: Nickel Plated
Materials: Jaw & Handle - Chrome Molybdenum

German Style					
Item No.	in / mm	mm	mm	mm	g
309HRE	10" / 255	31-60	75	74	790

Welder's Grip Wrenches Pipe Working



U-shaped clamping jaws, the upper jaws have V-profile to give secure three-point contact when clamping pipes. Provides quick clamping, fixed the round tube and processing, such as drilling, welding...etc.

Finish: Nickel Plated
Materials: Jaw & Handle - Chrome Molybdenum

German Style					
Item No.	in / mm	mm	mm	mm	g
309HRXE	10" / 280	65	75	74	800

Parallel Grip

Sliding moveable jaw & One-hand locking.

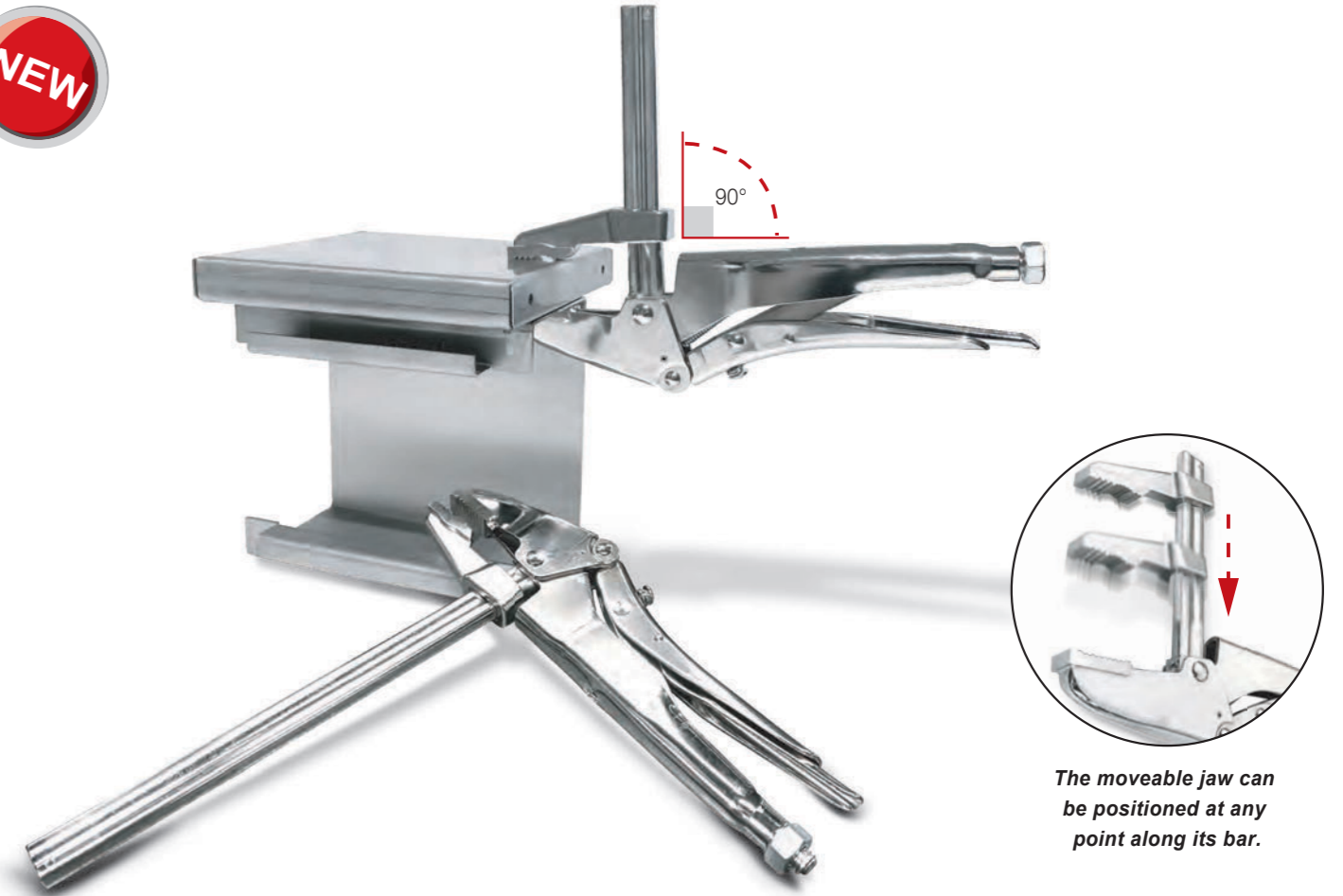

The moveable jaw can be positioned at any point along its bar.

The moveable jaw can be positioned at any point along its bar. This lets the operator quickly size the clamp precisely to the object without having to compensate for indexed or pre-sized settings.

All of the Parallel Grip are made from high-quality steels that have been precisely formed and treated with proprietary heat-treating processes to produce the best balance of hardness and strength. The designs of the jaws give them flex-fighting rigidity which increases the stability of the grip they develop.

* Pull the Release Lever to Loosen

Simply pull the release lever upwards motion to loosen the bite quickly and easily and straight to move on to your next work directly without readjusting jaw opening even if the works' thickness are different.

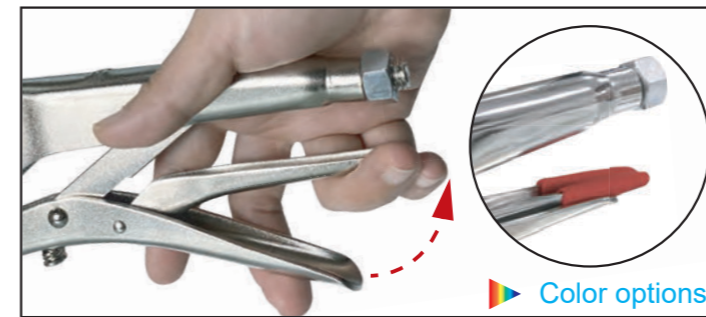

* Adjustable nut

The nut on the upper hand can adjust the jaw angle up to 7 degrees for clamping tapered parts or oblique surface.

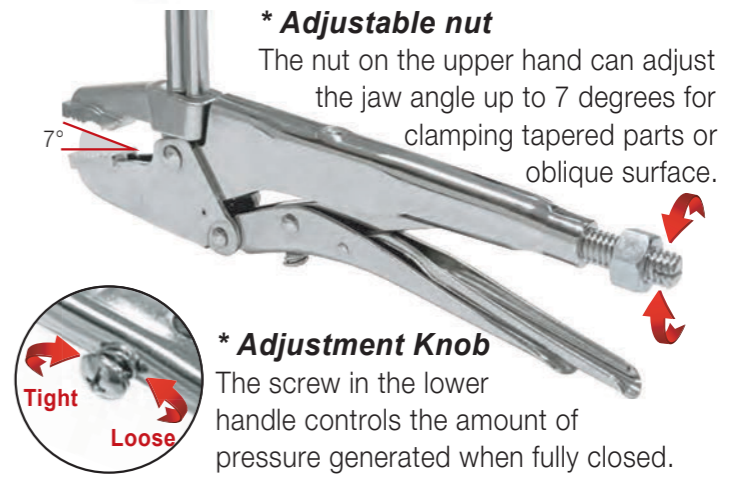

* Adjustment Knob

The screw in the lower handle controls the amount of pressure generated when fully closed.

Parallel Grip



Finish: Nickel Plated
Materials: Jaw & Handle - Chrome Molybdenum

German Style					
Item No.	in / mm	mm	mm	mm	g
310PSE	10" / 256	0-110	60	125	930
310PSLE	10" / 256	0-190	60	215	1045

Pistol Grips

Ideal for use in confined spaces.

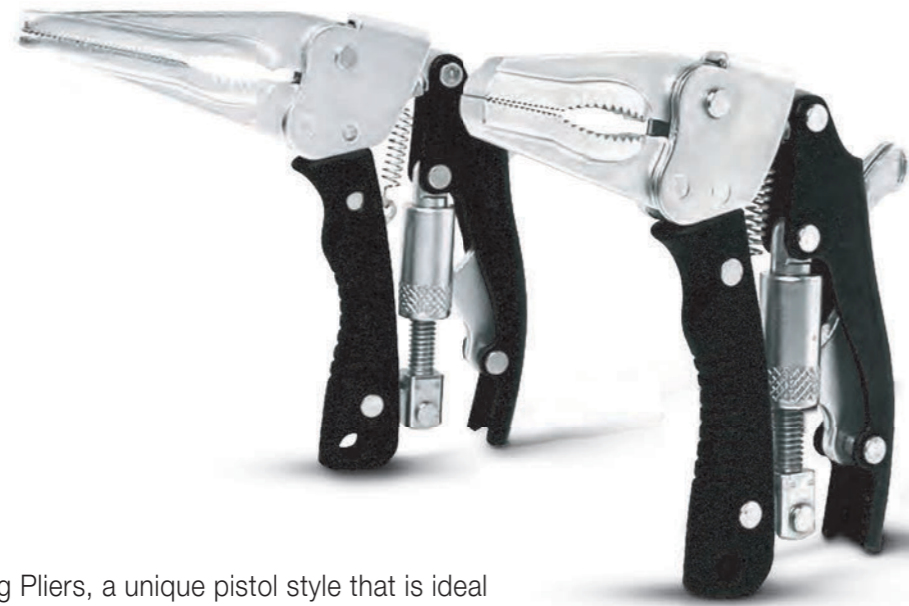

Pistol Grip Locking Pliers, a unique pistol style that is ideal for use in locations where do not allowed the use of regular locking pliers.

*** Protect wrist and provide up to 50% more force**

These pliers are intended to reduce hand strain and fatigue by keeping wrists straight and exert for up to 50% more force in twisting applications at the same time. Cushion grip helps reduce slippage with added comfort.

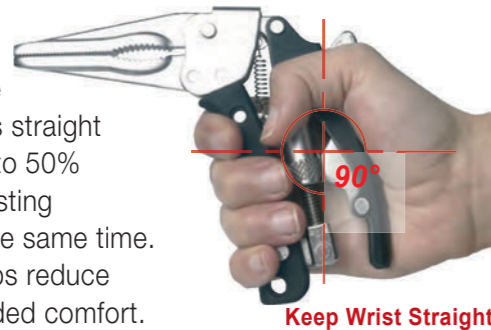

*** One hand easy work**

Thumb release and knurled adjustment screw for fast and easy work. Fantastic Power for Push-Pull-Torque actions! One hand use only.

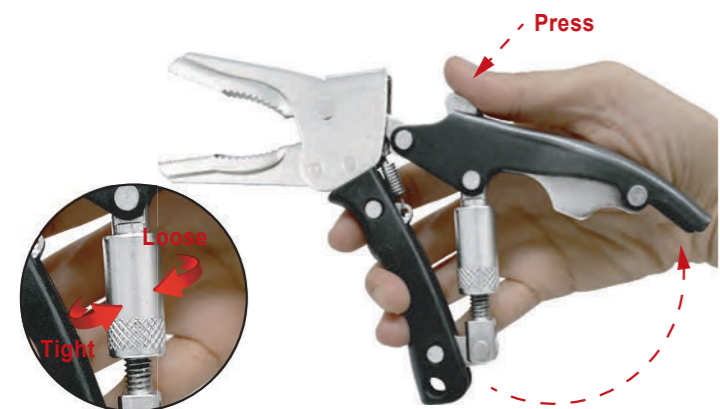

*** Limited spaces accesible**

Long jaw with straight and curved profiles for multiple applications and are ideal for use in confined spaces.

Pistol Grips



Finish: Nickel Plated
Materials: Jaw & Handle - Chrome Molybdenum

Item No.	in/mm	mm	mm	g
905	5" / 130	30	51	360
906	6" / 150	40	73	375

Locking Pliers Holder

Hands Free Work.



A very helpful hands-free portable work-holding system. You can use this jobsite holder with any size of locking pliers, expanding their utility by letting you create an improvised vise almost anywhere. Aids in a host of cutting, gluing, welding, and other applications.

*** Washer**

Washer ensures a firm hold on almost any work surface, without leaving scratch on it.

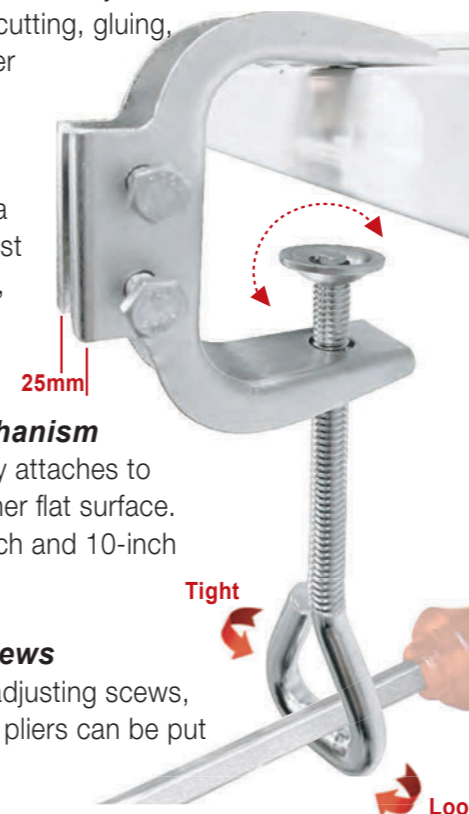

*** Holding Mechanism**

Quickly and easily attaches to workbench or other flat surface. Hold 5-inch, 7-inch and 10-inch locking pliers.

*** Adjusting Scews**

Thanks to the 4 adjusting scews, even 5-in locking pliers can be put in without gap.

*** Triangular Eye Thumb Lock Bolt**

Thumb grip to help fastening. It can be used powerfully with a screwdriver.



With 2 or more installed, sticks, bars, tubes or pipes in long length and even in different thickness can be easily clamped steadily. Then you can do the welding, sawing, or cutting work efficiently.

Locking Pliers Holder



Finish: Nickel Plated
Materials: Chrome Molybdenum

Item No.	mm	mm	mm	g
G410	137	75	25	255

Packaging Design

Blister

Blister Pack With Sliding Card

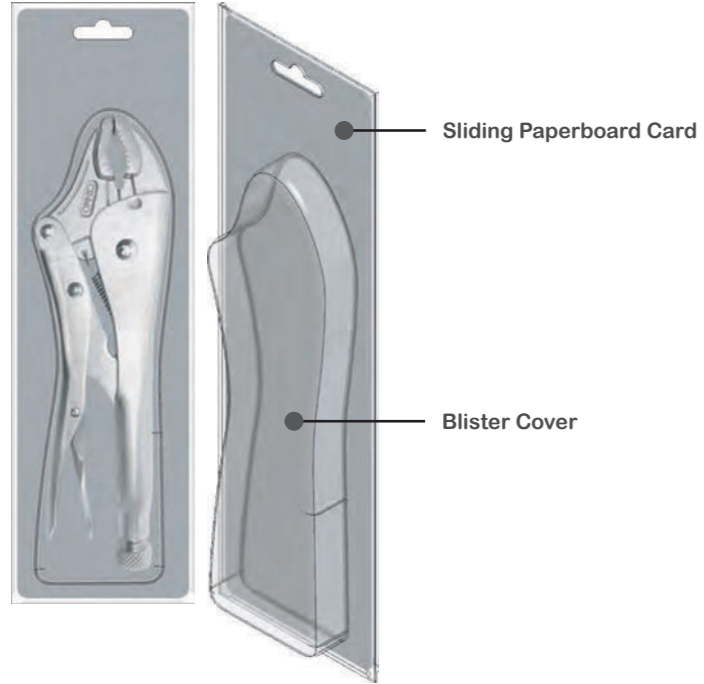

Half Double Blister-Sealed

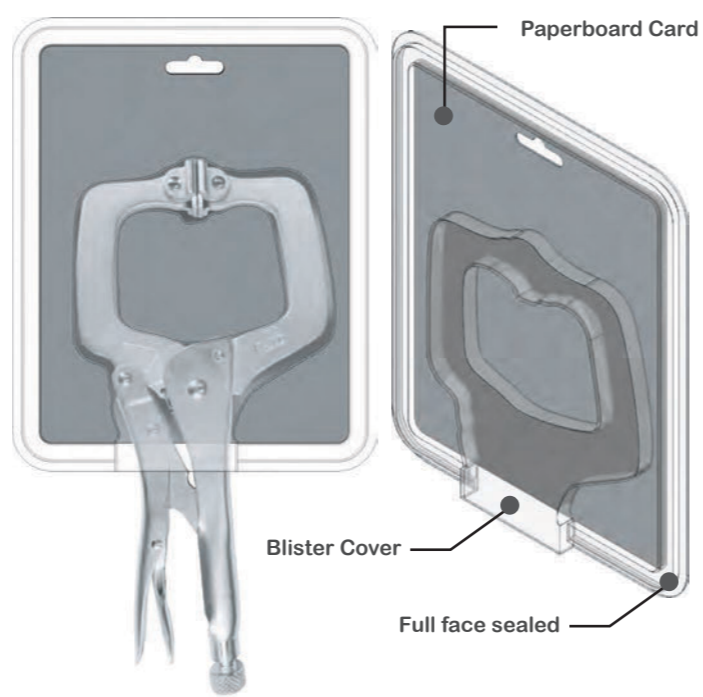

Blister

Half Double Blister-Pressed

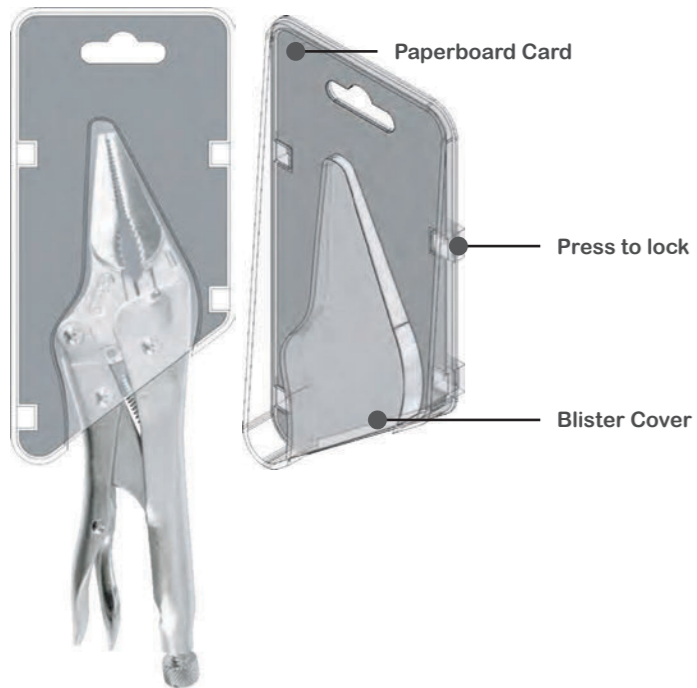

Trapped Blister

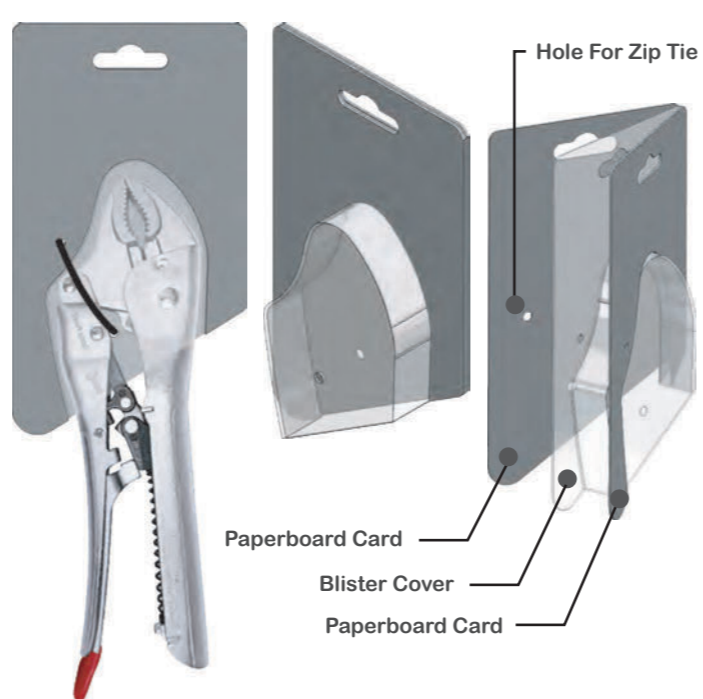

Packaging Design

Hanging Card

Paperboard Hanging Card

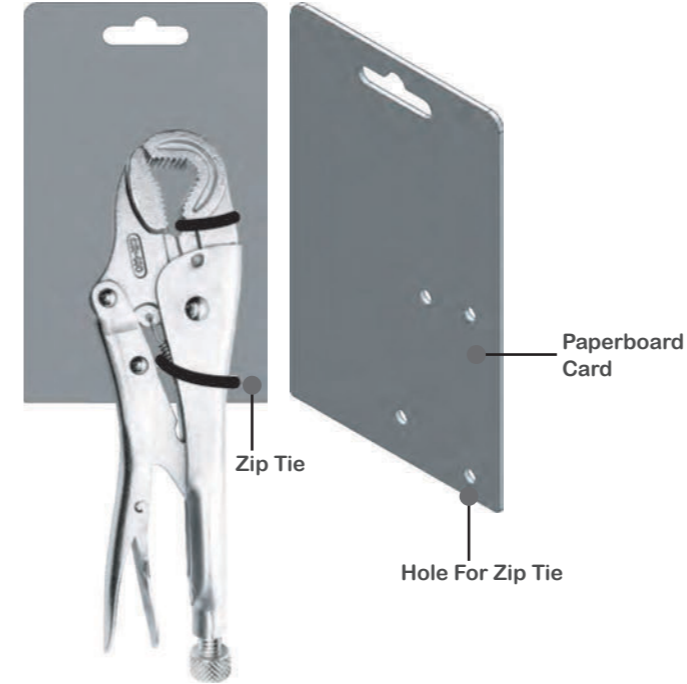

Black PP Hanging Card

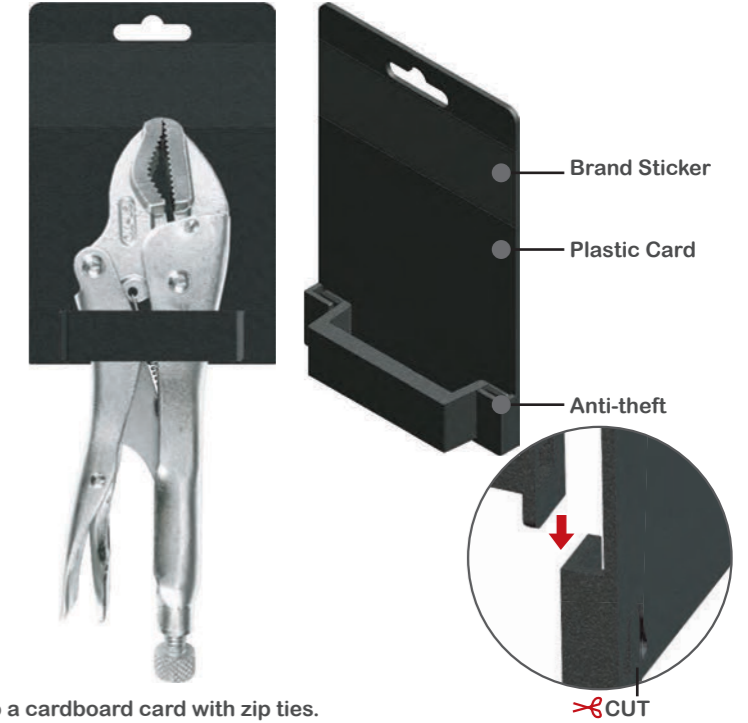

Paperboard / PP card with plastic attachment. The tool is attached to a cardboard card with zip ties.

Hanging Card

Black PP Hanging Card

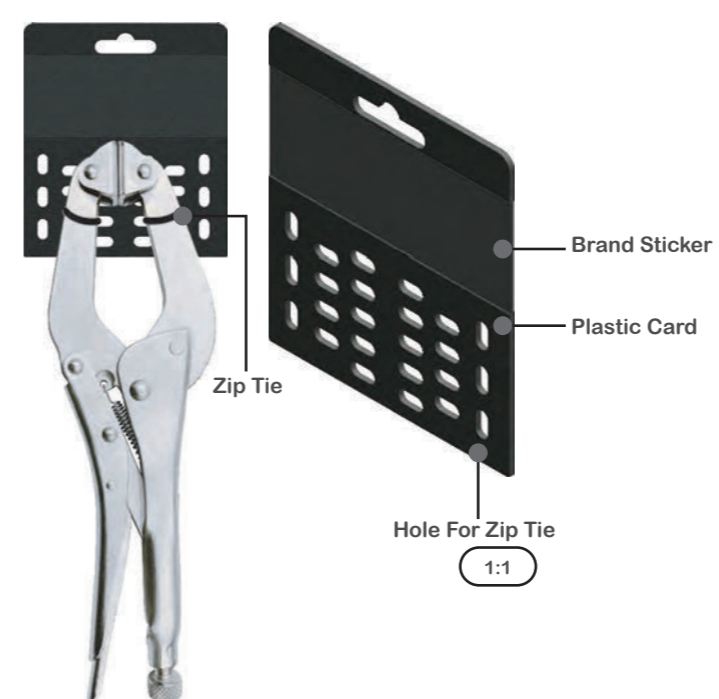

Black PP Hanging Card

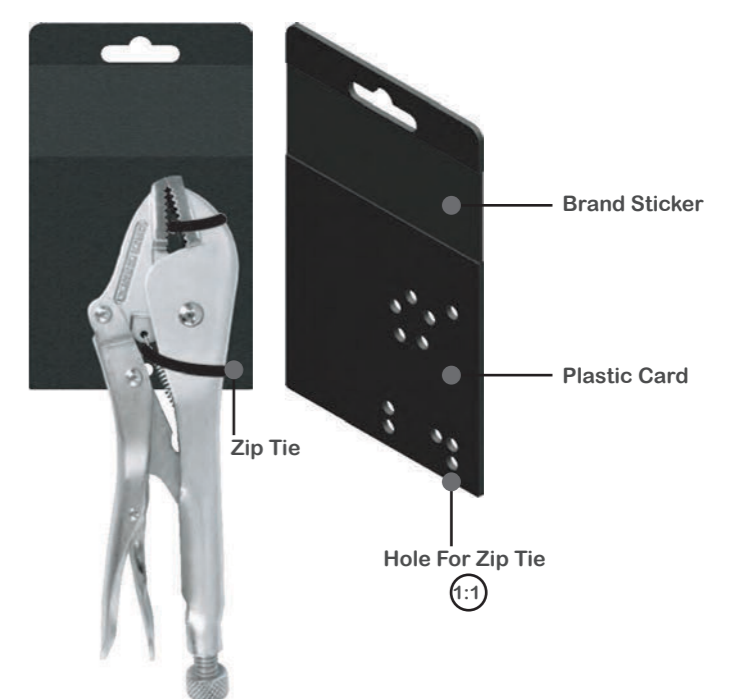

Packaging Design

Box

Window Box

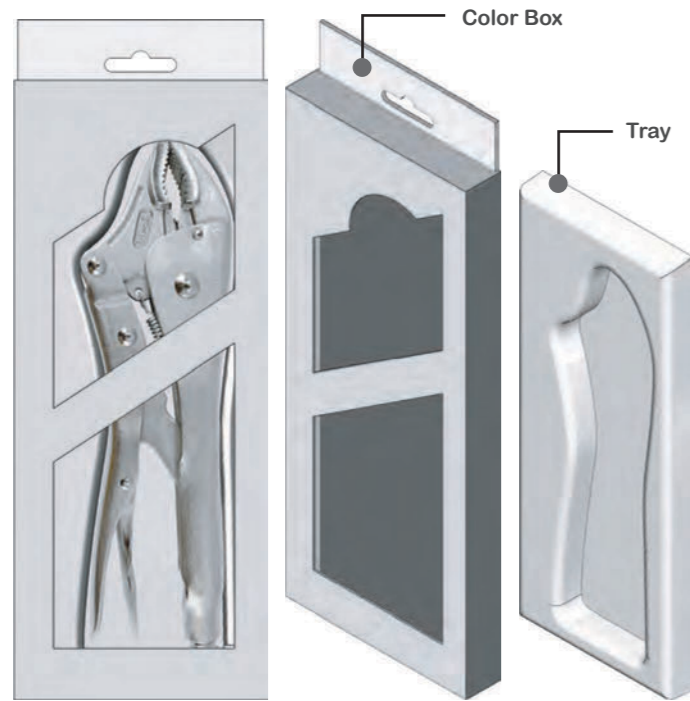

Display Box

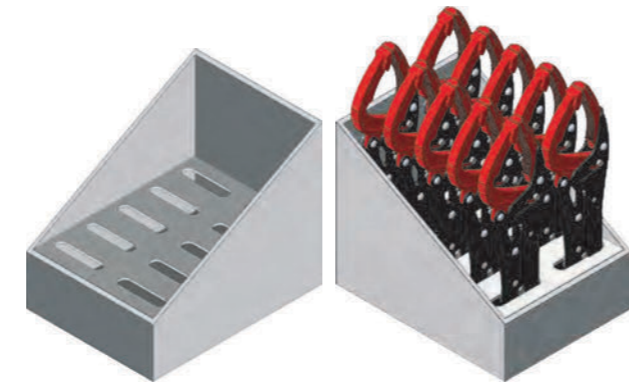

White / Color Box

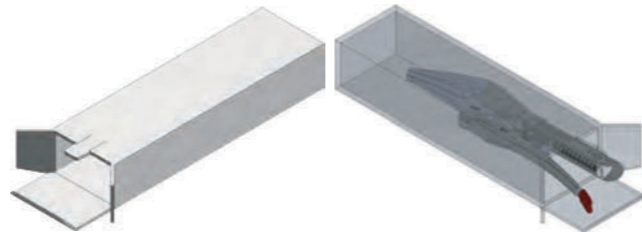

Other

Tray

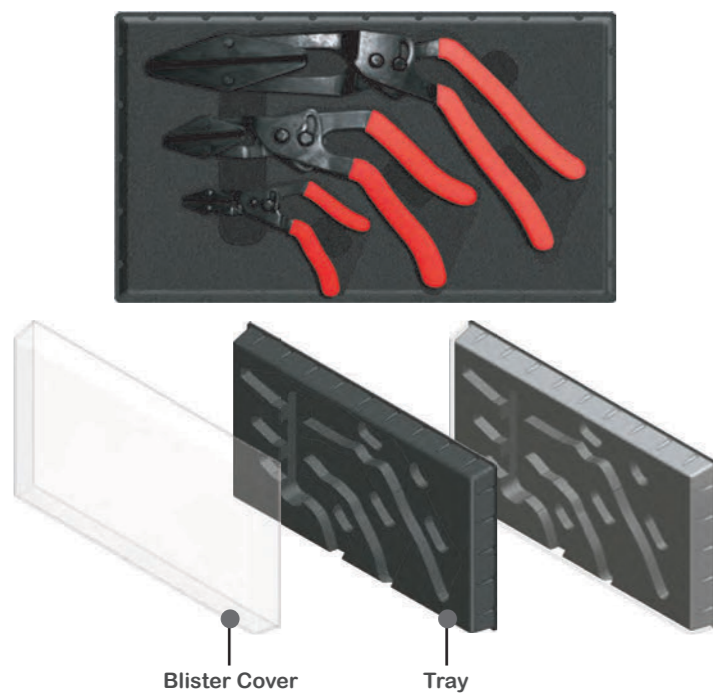

Pouch Bag For Sets

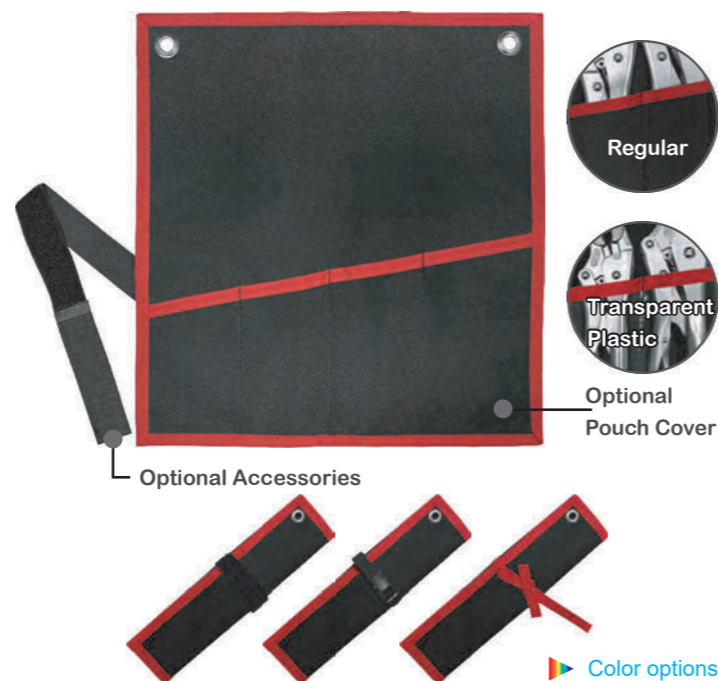

Market Application

	Welding	Automotive	Industry	Woodwork	Maintenance	Building
Locking Pliers						
P10 - Curved Jaw Locking Pliers	●	●	●	●	●	●
P11 - X-Jaw Locking Pliers	●	●	●	●	●	●
P11 - Straight Jaw Locking Pliers	●	●	●	●	●	●
P12 - Long Nose Locking Pliers	●	●	●	●	●	●
P12 - Round Jaw Locking Pliers	●	●	●	●	●	●
P13 - V Jaw Locking Pliers	●	●	●	●	●	●
P13 - W Jaw Locking Pliers	●	●	●	●	●	●
P14 - Large Jaw Locking Pliers	●	●	●	●	●	●
P15 - Lift Support Pliers	●	●	●	●	●	●
P15 - Hose Clamp Locking Pliers	●	●	●	●	●	●
P16 - Oil Filter Master Pliers	●	●	●	●	●	●
P16 - Parallel Jaw Locking Pliers	●	●	●	●	●	●
P17 - Mini Clamp Locking Pliers	●	●	●	●	●	●
P17 - Self-Evening Jaw Locking Pliers	●	●	●	●	●	●

Locking Chain Wrenches

P18 - Locking Chain Wrenches	●	●	●	●	●	●
P18 - Cutting Chain Wrenches	●	●	●	●	●	●

BSET Series Locking Pliers

P20 - BSET Series Locking Pliers	●	●	●	●	●	●
----------------------------------	---	---	---	---	---	---

Automatic Locking Pliers

P21 - Curved Jaw Locking Pliers	●	●	●	●	●	●
P21 - Straight Jaw Locking Pliers	●	●	●	●	●	●
P22 - Long Nose Jaw Locking Pliers	●	●	●	●	●	●
P22 - Welder's Grip Wrench	●	●	●	●	●	●
P22 - Locking C-Clamps	●	●	●	●	●	●
P26 - Screw Removal Locking Pliers	●	●	●	●	●	●

Screw Movable Locking Pliers

P24 - Screw Movable Locking Pliers	●	●	●	●	●	●
------------------------------------	---	---	---	---	---	---

Grip Wrenches

P25 - Locking Panel Clamps	●	●	●	●	●	●
P26 - Welder's Grip Wrenches	●	●	●	●	●	●
P26 - Welder's Grip Wrenches Pipe Working	●	●	●	●	●	●
P27 - Sheet Metal Grips	●	●	●	●	●	●
P27 - Roofers Welder Grip Wrench	●	●	●	●	●	●

Pinch Off

P28 - Pinch Off Pliers (Angle)	●	●	●	●	●	●
P28 - Pinch Off Pliers (Straight)	●	●	●	●	●	●
P29 - Hose Clamp Pliers (Angle)	●	●	●	●	●	●
P29 - Hose Clamp Pliers (Straight)	●	●	●	●	●	●
P29 - Pinch Off Locking Pliers	●	●	●	●	●	●
P30 - Straight Nose Hose Pinch Pliers	●	●	●	●	●	●
P30 - Angle Nose Hose Pinch Pliers	●	●	●	●	●	●

Expanding Locking Pliers

P33 - Expanding Locking Pliers	●	●	●	●	●	●
--------------------------------	---	---	---	---	---	---

	Welding	Automotive	Industry	Woodwork	Maintenance	Building
C-Clamps						
P36 - Stepped C-Clamps	●	●	●	●	●	●
P36 - Locking C-Clamps With PVC Covered	●	●	●	●	●	●
P37 - Locking C-Clamps	●	●	●	●	●	●
P38 - Locking C-Clamps With Swiver Pads	●	●	●	●	●	●

Table C-Clamps

P40 - 41 Replaceable Table C-Clamps	●	●	●	●	●	●
P42 - Table C-Clamps	●	●	●	●	●	●
P42 - T Slot Clamp With Pipe	●	●	●	●	●	●
P42 - Drill Press Clamp	●	●	●	●	●	●

Locking C-Clamps EUR Series

P39 - Locking C-Clamps EUR Series	●	●	●	●	●	●
-----------------------------------	---	---	---	---	---	---

Woodwork Clamp

P43 - 90° Corner Woodwork Clamp	●	●	●	●	●	●
P44 - 2-Way Right Angle Woodwork Clamp	●	●	●	●	●	●

Axial Welding

P46 - W Type	●	●	●	●	●	●
P46 - T Type	●	●	●	●	●	●
P46 - JJ Type	●	●	●	●	●	●
P46 - J Type	●	●	●	●	●	●
P46 - LL Type	●	●	●	●	●	●
P46 - L Type	●	●	●	●	●	●

French Type

P48 - Straight Jaw	●	●	●	●	●	●
P48 - Curved Jaw	●	●	●	●	●	●
P48 - Curved Jaw with Swivel Pads	●	●	●	●	●	●
P48 - Large Jaw	●	●	●	●	●	●

German Type

P50 - Curved Jaw German Type	●	●	●	●	●	●
P50 - Parallel Plus Grip Pliers	●	●	●	●	●	●
P50 - V Jaw Locking Pliers	●	●	●	●	●	●
P50 - VVE Jaw Locking Pliers	●	●	●	●	●	●
P51 - Angled Grip Wrench	●	●	●	●	●	●
P51 - Welder's Grip Wrenches	●	●	●	●	●	●
P51 - Welder's Grip Wrenches Pipe Working	●	●	●	●	●	●

Parallel grip

P52 - Parallel grip	●	●	●	●	●	●
---------------------	---	---	---	---	---	---

Pistol Grips

P53 - Pistol Grips	●	●	●	●	●	●
--------------------	---	---	---	---	---	---

Locking Pliers Holder

P54 - Locking Pliers Holder	●	●	●	●	●	●
-----------------------------	---	---	---	---	---	---

Memorandum

GONG MAWe can do more than you can imagine and never stop exploring.

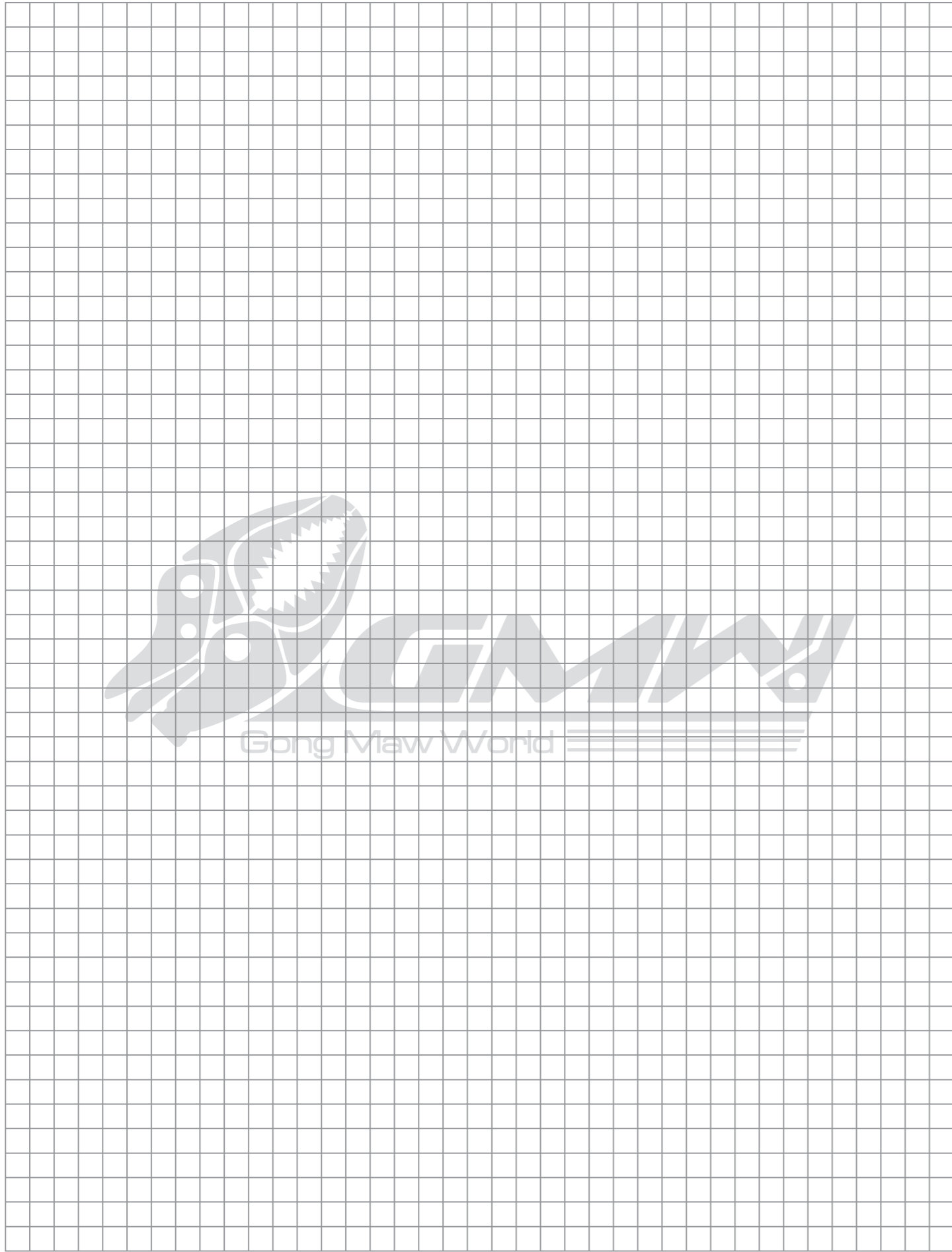

Memorandum

GONG MAWe can do more than you can imagine and never stop exploring.

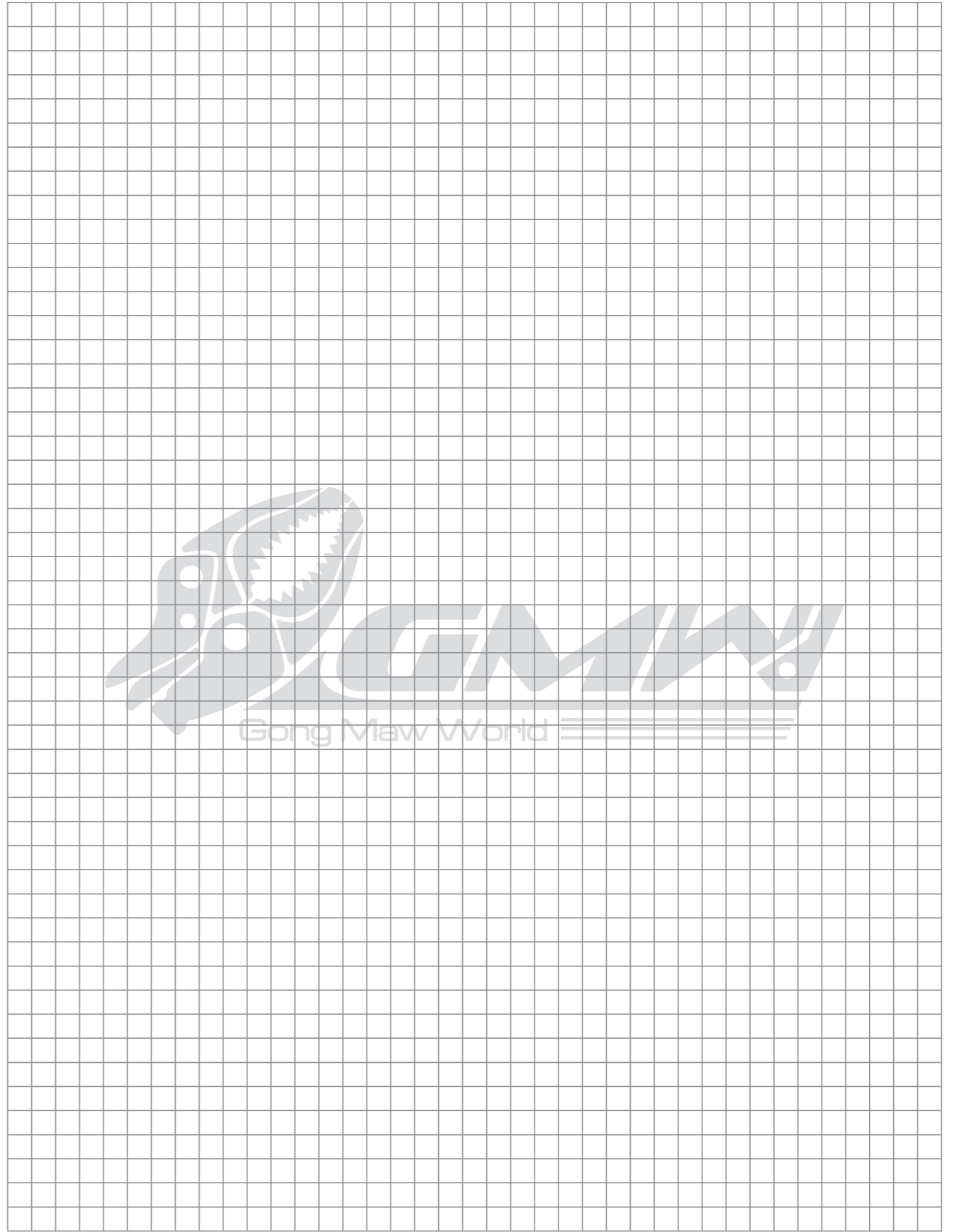

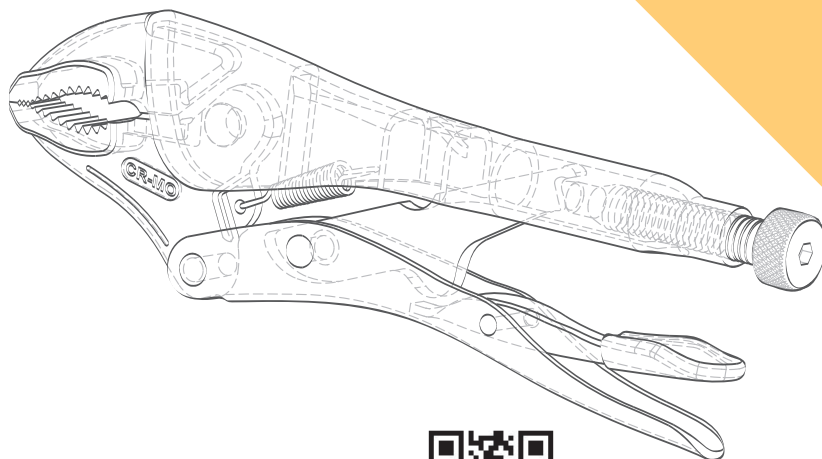

www.gongmaw.com

共茂工業股份有限公司
GONG MAW ENTERPRISE CO., LTD.

NO. 78, LN. 189, WUGUANG RD., WURI DIST., TAICHUNG CITY 414016, TAIWAN

414016台中市烏日區五光路189巷78號

TEL +886 4 2262 8198 FAX +886 4 2338 6838

EMAIL: service@gongmaw.com

